

**GARMIN®**

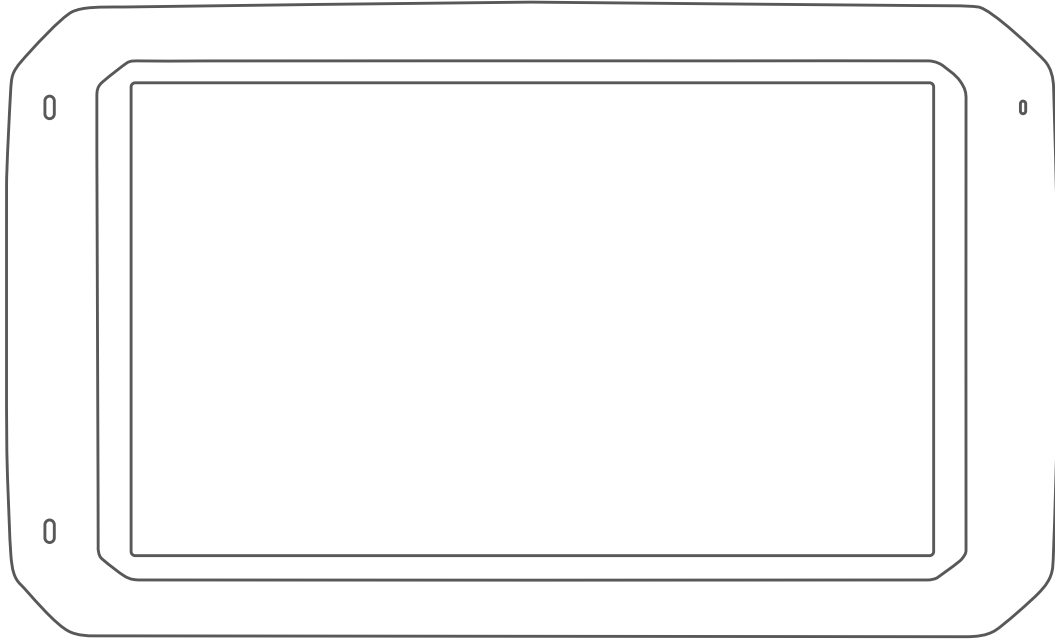

# OVERLANDER™

---

## Owner's Manual

© 2019 Garmin Ltd. or its subsidiaries

All rights reserved. Under the copyright laws, this manual may not be copied, in whole or in part, without the written consent of Garmin. Garmin reserves the right to change or improve its products and to make changes in the content of this manual without obligation to notify any person or organization of such changes or improvements. Go to [www.garmin.com](http://www.garmin.com) for current updates and supplemental information concerning the use of this product.

Garmin®, the Garmin logo, Fusion®, and inReach® are trademarks of Garmin Ltd. or its subsidiaries, registered in the USA and other countries. BC™, Fusion-Link™, Garmin Express™, Garmin Explore™, Garmin PowerSwitch™, myTrends™, and Overlander™ are trademarks of Garmin Ltd. or its subsidiaries. These trademarks may not be used without the express permission of Garmin.

Android™ is a trademark of Google Inc. Apple®, iPhone®, and Mac® are trademarks of Apple Inc, registered in the U.S. and other countries. The Bluetooth® word mark and logos are owned by the Bluetooth SIG, Inc., and any use of such name by Garmin is under license. Foursquare® is a trademark of Foursquare Labs, Inc. in the U.S. and in other countries. HD Radio™ Technology manufactured under license from iBiquity Digital Corporation. For patents see <http://patents.dts.com/>. HD Radio™ and the HD, HD Radio, and "Arc" logos are registered trademarks or trademarks of iBiquity Digital Corporation in the United States and/or other countries. HISTORY® and the H logo are trademarks of A+E Networks and are protected in the United States and other countries around the globe. All Rights Reserved. Used with Permission. iOverlander™ is a trademark of iOverlander. microSD® is a trademark of SD-3C. PlanRV™ is the trademark of TruckDown Info International, Inc. TripAdvisor® is a registered trademark of TripAdvisor LLC. Ultimate Campgrounds is a trademark of The Ultimate Public Campground Project. Wi-Fi® is a registered trademark of Wi-Fi Alliance. Windows® is a registered trademark of Microsoft Corporation in the United States and other countries.

# Table of Contents

<b>Getting Started.....</b>	<b>1</b>	Changing the Route Calculation Mode.....	12
Device Overview.....	2	Stopping the Route.....	13
Mounting and Powering the Device in Your Vehicle.....	3	Using Suggested Routes.....	13
Turning the Device On or Off.....	4	Avoiding Delays, Tolls, and Areas.....	13
Acquiring GPS Signals.....	5	Avoiding Traffic Delays on Your Route.....	13
Home Screen.....	5	Avoiding Toll Roads.....	13
Opening an App.....	5	Avoiding Toll Stickers.....	13
Adding Shortcuts to the Home Screen.....	6	Avoiding Road Features.....	14
Viewing Notifications.....	6	Avoiding Environmental Zones.....	14
Status Bar Icons.....	6	Custom Avoidances.....	14
Using the Touchscreen.....	6	Avoiding a Road.....	14
Adjusting the Screen Brightness.....	6	Avoiding an Area.....	14
		Disabling a Custom Avoidance....	14
		Deleting Custom Avoidances.....	14
<b>Vehicle Profiles.....</b>	<b>7</b>	<b>Finding and Saving Locations.....</b>	<b>15</b>
Car Profile.....	7	Points of Interest.....	15
Adding a Vehicle Profile.....	7	Navigating to a Garmin Explore Location.....	15
Switching the Vehicle Profile.....	7	Finding a Location by Category.....	15
Editing a Vehicle Profile.....	7	Searching Within a Category.....	15
		Finding Campgrounds.....	15
<b>Driver Awareness Features and Alerts.....</b>	<b>8</b>	Finding RV Parks.....	16
Enabling or Disabling Audible Driver Alerts.....	8	Finding Ultimate Campgrounds Points of Interest.....	16
Red Light and Speed Cameras.....	8	Finding RV Services.....	16
		Finding National Parks.....	16
<b>Street Navigation.....</b>	<b>9</b>	Exploring National Park Features and Amenities.....	16
Routes.....	9	Finding iOverlander™ Points of Interest.....	17
Starting a Route.....	9	Finding HISTORY® Points of Interest.....	17
Starting a Route by Using the Map....	9	Foursquare.....	17
Going Home.....	9	Searching Foursquare Points of Interest.....	17
Editing Your Home Location.....	9	TripAdvisor®.....	17
Your Route on the Map.....	10	Finding TripAdvisor Points of Interest.....	17
Active Lane Guidance.....	11	Navigating to Points of Interest Within a Venue.....	18
Viewing Turns and Directions.....	11	Exploring a Venue.....	18
Viewing the Entire Route on the Map.....	11	Finding a Location Using the Search Bar.....	18
Arriving at Your Destination.....	11	Finding an Address.....	18
Parking Near Your Destination.....	11	Location Search Results.....	19
Changing Your Active Route.....	12		
Adding a Location to Your Route....	12		
Shaping Your Route.....	12		
Taking a Detour.....	12		

Location Search Results on the Map.....	20	Customizing the Trip Data Fields.....	27
Changing the Search Area.....	20	Viewing the Trip Information Page..	27
Custom Points of Interest.....	21	Viewing the Trip Log.....	27
Installing POI Loader.....	21	Resetting Trip Information.....	27
Finding Custom POIs.....	21	Viewing Upcoming Traffic.....	27
Parking.....	21	Viewing Traffic on the Map.....	28
Finding Parking Near Your Current Location.....	21	Searching for Traffic Incidents.....	28
Understanding Parking Colors and Symbols.....	21	Customizing the Map.....	28
Search Tools.....	21	Customizing the Map Layers.....	28
Finding an Intersection.....	21	Changing the Map Data Field.....	28
Finding a City.....	21	Changing the Map Perspective.....	28
Finding a Location Using Coordinates.....	22	<b>Off-Road Navigation.....</b>	<b>29</b>
Viewing Recently Found Locations.....	22	Garmin Explore.....	29
Clearing the List of Recently Found Locations.....	22	Logging In to a Garmin Explore Account.....	30
Viewing Current Location Information.....	22	Map.....	30
Finding Emergency Services and Fuel.....	22	Downloading Garmin Explore Maps.....	30
Getting Directions to Your Current Location.....	22	Filtering Map Data.....	30
Adding a Shortcut.....	22	Garmin Explore Map Settings.....	30
Removing a Shortcut.....	23	Creating a Waypoint.....	31
Saving Locations.....	23	Creating a Route.....	31
Saving a Location.....	23	Library.....	31
Saving Your Current Location.....	23	Viewing Your Library.....	31
Editing a Saved Location.....	23	Navigating to a Saved Location...	31
Assigning Categories to a Saved Location.....	23	Creating a Collection.....	31
Deleting a Saved Location.....	24	Viewing Collections.....	31
<b>Using the Street Map.....</b>	<b>24</b>	Synchronizing Garmin Explore Account Data.....	32
Map Tools.....	24	Importing GPX Files with a Memory Card.....	32
Viewing a Map Tool.....	24	Exporting GPX Files with a Memory Card.....	32
Up Ahead.....	24	Recording Tracks.....	32
Viewing Upcoming Locations.....	25	Changing Tracking Intervals.....	32
Customizing the Up Ahead Categories.....	25	Stopping Tracking.....	33
Warning and Alert Symbols.....	25	Pitch and Roll.....	33
Restriction Warnings.....	26	Calibrating Pitch and Roll.....	33
Road Condition Warnings.....	26	Adjusting Warning Angles.....	33
Alerts.....	27	Enabling or Disabling Warning Angle Alerts.....	33
Trip Information.....	27	Viewing the Altimeter, Barometer, and Compass.....	33
Viewing Trip Data from the Map.....	27	Calibrating the Compass.....	34
		<b>inReach Remote.....</b>	<b>34</b>

Connecting an inReach Device.....	34	Selecting a Source.....	40
Sending an inReach Message.....	34	Playback Controls.....	40
SOS.....	34	Audio Control.....	41
Initiating an SOS Rescue.....	35	Adjusting the Volume for a	
Canceling an SOS Rescue.....	35	Zone.....	41
<b>Hands-Free Calling.....</b>	<b>35</b>	Adjusting the Tones.....	41
Pairing Your Phone.....	35	Disabling the Loud Setting for a	
Tips After Pairing the Devices.....	36	Zone.....	41
Pairing Additional Bluetooth		Adjusting the Gain for an Auxiliary	
Devices.....	36	Device.....	41
Placing a Call.....	36	Speaker Zones.....	41
Receiving a Call.....	36	DSP Settings.....	42
Using In-Call Options.....	36	Presets.....	42
Saving a Phone Number as a Preset...	36	Saving a Station as a Preset.....	42
Disconnecting a Bluetooth Device.....	37	Selecting a Preset from a List.....	42
Deleting a Paired Bluetooth Device.....	37	Removing Presets.....	42
Deleting a Paired Phone.....	37	Audio Settings.....	43
		Speaker Zone Settings.....	43
		Garmin PowerSwitch™ App.....	44
		Activating a Power Switch.....	44
		Turning Off All Switches.....	44
		Customizing a Button.....	45
		Assigning a Switch to a Control	
		Input.....	45
		Adding a Custom Layout.....	45
		Adding a Button to a Custom	
		Layout.....	46
		Arranging Buttons In a Custom	
		Layout.....	46
		Deleting a Custom Layout or	
		Button.....	46
<b>Traffic.....</b>	<b>37</b>	<b>Overlander Settings.....</b>	<b>47</b>
Receiving Traffic Data Using a Traffic		Navigation Settings.....	47
Receiver.....	37	Map and Vehicle Settings.....	47
Enabling Traffic.....	38	Enabling Maps.....	47
Viewing Traffic on the Map.....	38	Route Preference Settings.....	47
Searching for Traffic Incidents.....	38	Driver Assistance Settings.....	48
		Traffic Settings.....	48
		Enabling Bluetooth Wireless	
		Technology.....	48
		Connecting to a Wireless Network.....	48
		Display Settings.....	48
		Sound and Notification Settings.....	49
		Adjusting Sound and Notification	
		Volume.....	49
		Enabling or Disabling Location	
		Services.....	49
<b>Voice Command.....</b>	<b>38</b>		
Setting the Wakeup Phrase.....	38		
Activating Voice Command.....	38		
Voice Command Tips.....	38		
Starting a Route Using Voice			
Command.....	39		
Muting Instructions.....	39		
<b>Using the Apps.....</b>	<b>39</b>		
Viewing the Owner's Manual on			
Your Device.....	39		
Viewing Previous Routes and			
Destinations.....	39		
Fusion-Link™ Wireless Remote Control			
App.....	39		
Connecting to a Stereo Using			
Bluetooth.....	39		
Connecting to a Stereo Using a			
Wireless Network.....	40		
Music Playback.....	40		
Playing Music.....	40		

Setting the Text Language.....	49	Garmin PowerSwitch.....	56
Date and Time Settings.....	49	Mounting Considerations.....	56
Device Settings.....	49	Mounting the Device.....	56
Restoring Settings.....	50	Opening the Front Cover.....	57
Resetting Data and Settings.....	50	Connecting Accessories.....	58
<b>Device Information.....</b>	<b>50</b>	Connecting a Control Input.....	59
Viewing E-label Regulatory and		Connecting the Device to Vehicle	
Compliance Information.....	50	Power.....	60
Specifications.....	50	Pairing with a Garmin Navigation	
Charging the Device.....	50	Device.....	61
<b>Device Maintenance.....</b>	<b>51</b>	Garmin PowerSwitch	
Garmin Support Center.....	51	Specifications.....	61
Updating Maps and Software Using a		Troubleshooting.....	61
Wi-Fi Network.....	51	My Garmin PowerSwitch will not	
Updating Maps and Software with		stay connected.....	61
Garmin Express.....	52	My accessories are not receiving	
Installing Garmin Express.....	53	power.....	61
Device Care.....	53	Backup Cameras.....	61
Cleaning the Outer Casing.....	53	Pairing a BC™ 35 Backup Camera with	
Cleaning the Touchscreen.....	53	a Garmin Navigation Device.....	62
Avoiding Theft.....	53	Viewing the Backup Camera.....	62
Changing the Fuse in the Vehicle Power		Switching Cameras.....	62
Cable.....	54	Changing the Camera	
Resetting the Device.....	54	Orientation.....	63
Removing the Device, Mount, and		Connecting to a Wireless Display.....	63
Suction Cup.....	54	Data Management.....	63
Removing the Mount from the Suction		About Memory Cards.....	63
Cup.....	54	Installing a Memory Card for Maps	
Removing the Suction Cup from the		and Data.....	63
Windshield.....	54	Formatting the Memory Card.....	63
<b>Troubleshooting.....</b>	<b>54</b>	Connecting the Device to Your	
The suction cup will not stay on my		Computer.....	64
windshield.....	54	Transferring Data From Your	
The mount does not hold my device in		Computer.....	64
place while I drive.....	55	Purchasing Additional Maps.....	64
My device is not acquiring satellite		Purchasing Accessories.....	64
signals.....	55	<b>Index.....</b>	<b>65</b>
The device does not charge in my			
vehicle.....	55		
My battery does not stay charged for			
very long.....	55		
My device does not connect to my			
phone.....	55		
<b>Appendix.....</b>	<b>56</b>		

# Getting Started

## WARNING

See the *Important Safety and Product Information* guide in the product box for product warnings and other important information.

---

- 1 Update the maps and software on your device (*Updating Maps and Software Using a Wi-Fi Network*, page 51).
- 2 Set up a Garmin Explore™ account (*Garmin Explore*, page 29).
- 3 Mount the device in your vehicle and connect it to power (*Mounting and Powering the Device in Your Vehicle*, page 3).
- 4 Set up a vehicle profile (*Vehicle Profiles*, page 7).
- 5 Navigate to your destination (*Starting a Route*, page 9).

## Device Overview

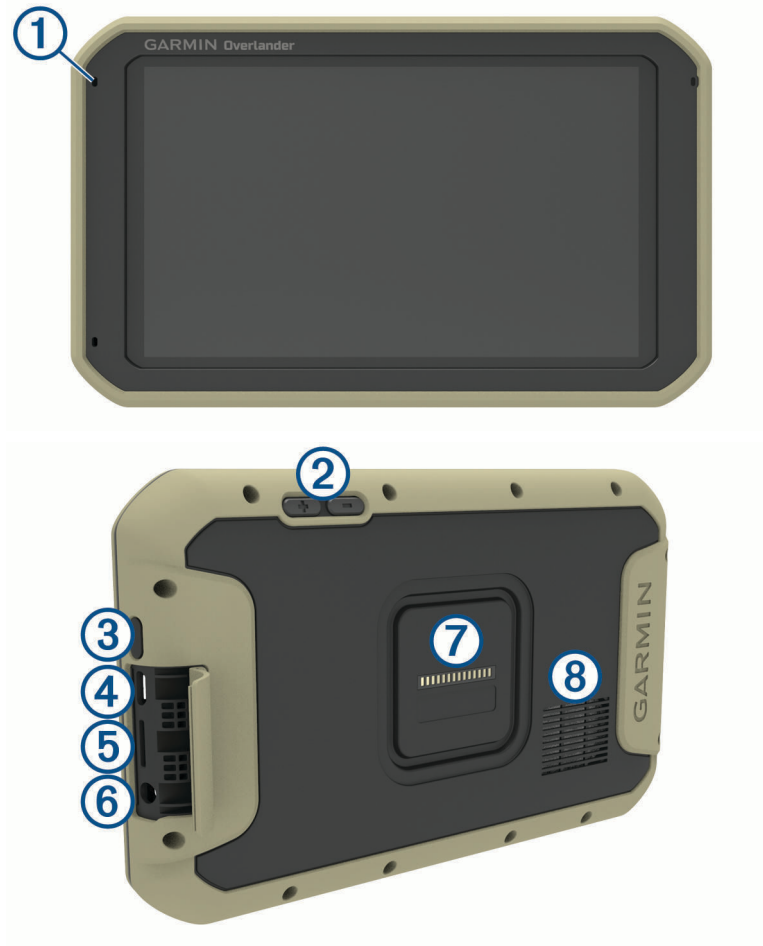

①	Microphone for hands-free calling
②	Volume control
③	Power key
④	Micro USB power and data port
⑤	Map and data memory card slot
⑥	3.5mm audio jack
⑦	Magnetic mount interface with 14 pin connector
⑧	Speaker



## Mounting and Powering the Device in Your Vehicle

### **⚠ WARNING**

This product contains a lithium-ion battery. To prevent the possibility of personal injury or product damage caused by battery exposure to extreme heat, store the device out of direct sunlight.

Both the device and its mount contain magnets. Under certain circumstances, magnets may cause interference with some internal medical devices and electronic devices, including pacemakers, insulin pumps, or hard drives in laptop computers. Keep the device away from medical devices and electronic devices.

Before you use your device on battery power, you should charge it.

- 1 Open the lever ①, press the suction cup to the windshield, and flip the lever back toward the windshield. The lever must be oriented toward the top of the windshield.

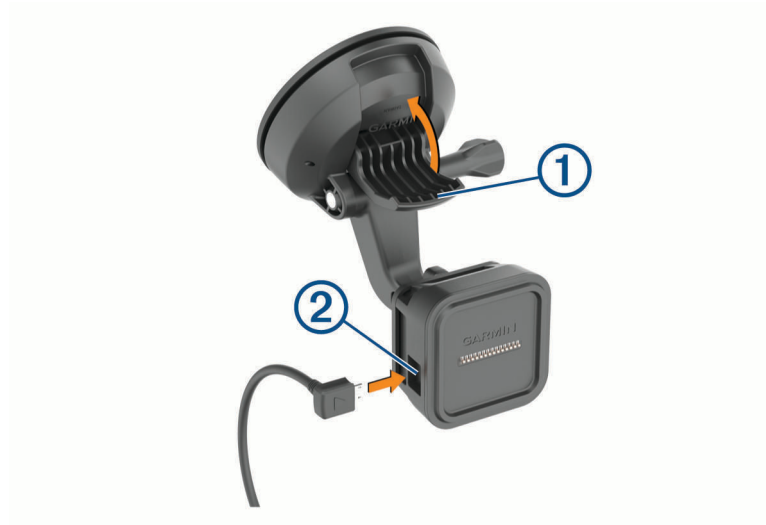

- 2 Plug the vehicle power cable into the port ② on the mount.
- 3 If necessary, loosen the thumbscrew on the suction cup arm ③ and the nut on the ball mount ④, and adjust the mount for better viewing and operation.



- 4 Tighten the thumbscrew on the suction cup arm and the nut on the ball mount.
- 5 Place the device onto the magnetic mount.



6 Plug the other end of the vehicle power cable into a power outlet in your vehicle.

### Turning the Device On or Off

- To turn the device on, press the power key **1**, or connect the device to power.

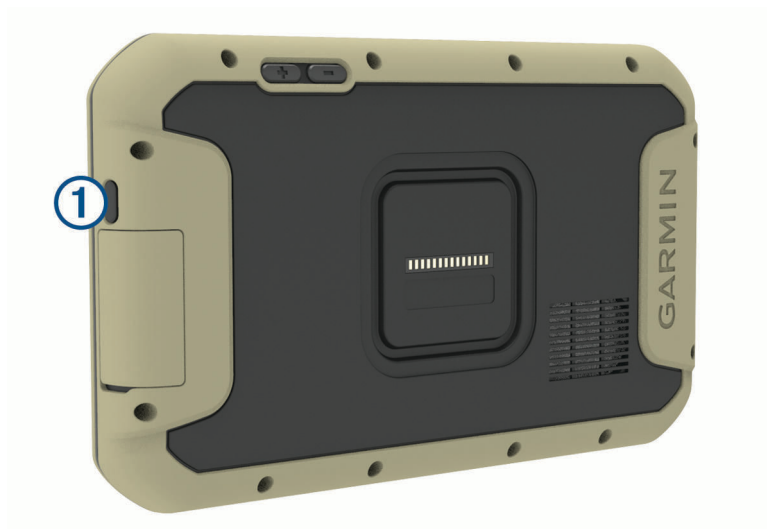

- To put the device in power saving mode, press the power key while the device is on. While in power saving mode, the screen is off and the device uses very little power, but it can wake instantly for use.  
**TIP:** You can charge your device faster by putting it in power saving mode while charging the battery.
- To turn off the device completely, hold the power key until a prompt appears on the screen, and select **Power Off**.

## Acquiring GPS Signals

When you turn on your navigation device, the GPS receiver must collect satellite data and establish the current location. The time required to acquire satellite signals varies based on several factors, including how far you are from the location where you last used your navigation device, whether you have a clear view of the sky, and how long it has been since you last used your navigation device. The first time you turn on your navigation device, it may take several minutes to acquire satellite signals.

- 1 Turn on the device.
- 2 Verify  appears in the status bar, and enable location services if it does not.
- 3 If necessary, go to an open area with a clear view of the sky, away from tall buildings and trees.  
Acquiring Satellites appears at the top of the navigation map until the device determines your location.

## Home Screen

**NOTE:** The home screen layout may vary if it has been customized.



- ① Swipe down to view notifications.  
Swipe down twice to quickly change settings and backlight brightness.
- ② Hold to customize the wallpaper or add widgets to the home screen.
- ③ Select to view road navigation features and search for points of interest.
- ④ Select to view the Garmin Explore app, which provides off-road navigation information and detailed topographical maps.
- ⑤ Select to open the app drawer. The app drawer contains shortcuts to all the apps installed on your device.

## Opening an App

The home screen contains shortcuts for frequently used apps. The app drawer contains all the apps installed on your device, organized into three tabs. The Drive tab contains apps useful for street navigation and various automotive needs. The Explore tab contains apps useful for off-road navigation and exploration. The Tools tab contains apps useful for communication and other tasks.

Select an option to start an app:

- Select an app shortcut from the home screen.
- Select , select a tab, and select an app.

## Adding Shortcuts to the Home Screen







- 1 Select .
- 2 Select an app tab to view additional applications.
- 3 Hold an application, and drag it to a location on the home screen.

## Viewing Notifications

- 1 Swipe down from the top of the screen.  
The list of notifications appears.
- 2 Select an option:
  - To launch the action or app mentioned in the notification, select the notification.
  - To dismiss a notification, swipe the notification to the right.

## Status Bar Icons

The status bar is located at the top of the main menu. The status bar icons display information about features on the device.

	Location services is enabled.
	Bluetooth® technology is enabled.
	Connected to a Bluetooth device.
	Connected to a Wi-Fi® network ( <a href="#">Connecting to a Wireless Network, page 48</a> ).
 	Active vehicle profile. Swipe down twice and select to view the vehicle profile settings ( <a href="#">Vehicle Profiles, page 7</a> ).
	Battery charge level.

## Using the Touchscreen

- Tap the screen to select an item.
- Drag or swipe your finger across the screen to pan or scroll.
- Pinch two fingers together to zoom out.
- Spread two fingers apart to zoom in.

## Adjusting the Screen Brightness

The device can use an ambient light sensor to adjust the screen brightness to your vehicle conditions automatically ([Display Settings, page 48](#)). You can also adjust the brightness manually, using either the notification panel or the settings menu.

- 1 Select an option:
  - Swipe down twice from the top of the screen to expand the quick settings in the notification panel.
  - Select  > **Display** > **Brightness Level**.
- 2 Use the slider bar to adjust the brightness.

# Vehicle Profiles

## WARNING

Entering your vehicle profile characteristics does not guarantee that your vehicle's characteristics will be accounted for in all route suggestions or that you will receive the warning icons in all cases. Limitations may exist in the map data such that your device cannot account for these restrictions or road conditions in all cases. Always defer to all posted road signs and road conditions when making driving decisions.

Routing and navigation are calculated differently based on your vehicle profile. The activated vehicle profile is indicated by an icon in the status bar. The navigation and map settings on your device can be customized separately for each vehicle type.



When you activate a camper vehicle profile, the device avoids including restricted or impassable areas in routes based on the dimensions, weight, and other characteristics you entered for your vehicle.

## Car Profile

The car profile is a preloaded vehicle profile intended for use in an automobile without a trailer. While using the car profile, the device calculates standard automobile routes, and routing for large vehicles is not available. Some features and settings specific to large vehicles are not available while using the car profile.



## Adding a Vehicle Profile

The vehicle profile is an optional feature that provides routing based on the height and weight of large vehicles, such as campers or trailers. If you have a large vehicle or if you are towing a trailer, you should set up a vehicle profile. You can set a vehicle profile for each vehicle configuration used with your Overlander device.

- 1 Select  >  > **Vehicle Profile** > .
- 2 Select a vehicle option which most closely resembles your vehicle configuration.
- 3 Follow the on-screen instructions to enter the vehicle characteristics.

## Switching the Vehicle Profile







The first time you turn on your device, it prompts you to select a vehicle profile. You can manually switch another vehicle profile at any time.

- 1 Select an option:
  - Swipe down twice from the top of the screen, and select the vehicle profile icon, such as  or .
  - Select  > **Navigation** > **Vehicle Profile**.
- 2 Select a vehicle profile.

The vehicle profile information appears, including measurements and weight.
- 3 Select **Select**.

## Editing a Vehicle Profile

You can change basic vehicle profile information or add detailed information to a vehicle profile, such as maximum speed.

- 1 Select  > **Navigation** > **Vehicle Profile**.
- 2 Select the vehicle profile to edit.
- 3 Select an option:
  - To edit the vehicle profile information, select , and select a field to edit.
  - To rename a vehicle profile, select  >  > **Rename Profile**.
  - To delete the vehicle profile, select  >  > **Delete**.

# Driver Awareness Features and Alerts

## ⚠ CAUTION

The driver alerts and speed limit features are for information only and do not replace your responsibility to abide by all posted speed limit signs and to use safe driving judgment at all times. Garmin® is not responsible for any traffic fines or citations you receive for failing to follow all applicable traffic laws and signs.

Your device provides features that can help encourage safer driving and increase efficiency, even when you are driving in a familiar area. The device plays an audible tone or message and displays information for each alert. You can enable or disable the audible tone for some types of driver alerts. Not all alerts are available in all areas.

**Schools:** The device plays a tone and displays the speed limit (if available) for an upcoming school or school zone.

**Speed limit exceeded:** The device plays a tone and displays a red border on the speed limit icon when you exceed the posted speed limit for the current road.

**Speed limit change:** The device plays a tone and displays the upcoming speed limit so you can be prepared to adjust your speed.

**Railroad crossing:** The device plays a tone to indicate an upcoming railroad crossing.

**Animal crossing:** The device plays a tone to indicate an upcoming animal crossing area.

**Curves:** The device plays a tone to indicate a curve in the road.

**Slower traffic:** The device plays a tone to indicate slower traffic when you approach slower traffic at a higher speed. Your device must be receiving traffic information to use this feature ([Traffic, page 37](#)).

**Risk of grounding:** The device plays a tone and displays a message when you approach a road where your vehicle could become grounded.

**Lateral wind:** The device plays a tone and displays a message when you approach a road where there is risk of lateral wind.

**Narrow road:** The device plays a tone and displays a message when you approach a road that may be too narrow for your vehicle.

**Steep hill:** The device plays a tone and displays a message when you approach a steep hill.

**State and country borders:** The device plays a tone and displays a message when you approach the border of a state or country.

**Shut off propane:** The device plays a tone and displays a message when you approach an area where propane should be turned off.

## Enabling or Disabling Audible Driver Alerts

You can enable or disable the audible tone for some types of driver alerts. The visual alert appears even when the tone is disabled.

- 1 Select  > **Navigation** > **Driver Assistance** > **Audible Driver Alerts**.
- 2 Select or clear the check box next to each alert.

## Red Light and Speed Cameras

### NOTICE

Garmin is not responsible for the accuracy of or the consequences of using a red light or speed camera database.

**NOTE:** This feature is not available for all regions or product models.

Information about red light and speed camera locations is available in some areas for some product models. The device alerts you when you approach a reported speed or red light camera.

- You can use the Garmin Express™ software ([garmin.com/express](http://garmin.com/express)) to update the camera database stored on your device. You should update your device frequently to receive the most up-to-date camera information.



# Street Navigation

## Routes

A route is a path from your current location to one or more destinations.

- The device calculates a recommended route to your destination based on the preferences you set, including the route calculation mode ([Changing the Route Calculation Mode, page 12](#)) and avoidances ([Avoiding Delays, Tolls, and Areas, page 13](#)).
- The device can automatically avoid roads that are not appropriate for the active vehicle profile.
- You can start navigating to your destination quickly using the recommended route, or you can select an alternate route ([Starting a Route, page 9](#)).
- If there are specific roads you need to use or avoid, you can customize the route.
- You can add multiple destinations to a route.

## Starting a Route



- 1 Select , and search for a location.
- 2 Select a location.
- 3 Select an option:
  - To start navigating using the recommended route, select **Go!**.
  - To choose an alternate route, select , and select a route.  
Alternate routes appear to the right of the map.
  - To edit the course of the route, select  > **Edit Route**, and add shaping points to the route.

The device calculates a route to the location and guides you using voice prompts and information on the map ([Your Route on the Map, page 10](#)). A preview of the major roads in your route appears at the edge of the map for several seconds.

If you need to stop at additional destinations, you can add the locations to your route.

## Starting a Route by Using the Map

You can start route by selecting a location from the map.



- 1 Select **Drive**.
- 2 Drag and zoom the map to display the area to search.
- 3 If necessary, select  to filter the displayed points of interest by category.  
Location markers ( or a blue dot) appear on the map.
- 4 Select an option:
  - Select a location marker.
  - Select a point, such as a street, intersection, or address location.
- 5 Select **Go!**.

## Going Home

The first time you start a route home, the device prompts you to enter your home location.

- 1 Select  > **Go Home**.
- 2 If necessary, enter your home location.

## Editing Your Home Location

- 1 Select  >  > **Set Home Location**.
- 2 Enter your home location.

## Your Route on the Map

As you travel, the device guides you to your destination using voice prompts and information on the map. Instructions for your next turn, exit, or other action appear across the top of the map.

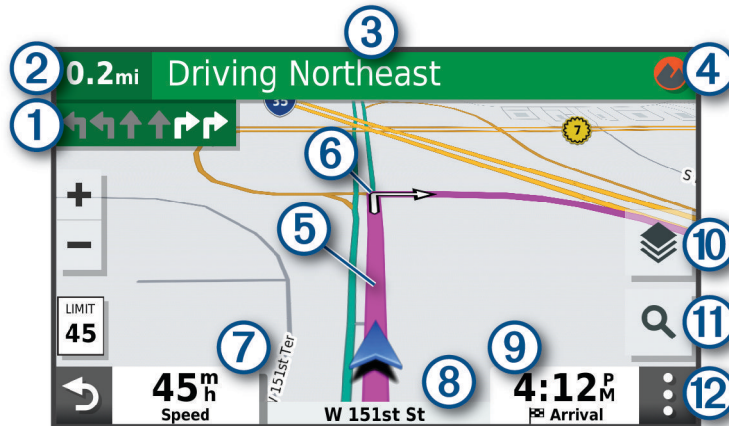

- ① Next action in the route. Indicates the next turn, exit, or other action and the lane in which you should travel, if available.
- ② Distance to the next action.
- ③ Name of the street or exit associated with the next action.
- ④ Opens the Garmin Explore app for off-road navigation.
- ⑤ Route highlighted on the map.
- ⑥ Next action in the route. Arrows on the map indicate the location of upcoming actions.
- ⑦ Vehicle speed.
- ⑧ Name of the road on which you are traveling.
- ⑨ Estimated arrival time.  
**TIP:** You can touch this field to change the information it shows.
- ⑩ Map layers. Allows you to add map layers such as topographic and BirdsEye imagery to your map view.
- ⑪ Select to start a new route or search for points of interest.
- ⑫ Map tools. Provides tools to show you more information about your route and surroundings.



## Active Lane Guidance

As you approach some turns, exits, or interchanges in your route, a detailed simulation of the road appears beside the map, if available. A colored line ① indicates the proper lane for the turn.



## Viewing Turns and Directions

While navigating a route, you can view upcoming turns, lane changes, or other directions for your route.

- 1 From the map, select an option:
  - To view upcoming turns and directions as you navigate, select **> Turns**.  
The map tool displays the next four turns or directions beside the map. The list updates automatically as you navigate the route.
  - To view the complete list of turns and directions for the entire route, select the text bar at the top of the map.
- 2 Select a turn or direction (optional).  
Detailed information appears. An image of the junction may appear for junctions on major roadways, if available.

## Viewing the Entire Route on the Map

- 1 While navigating a route, select anywhere on the map.
- 2 Select .

## Arriving at Your Destination

When you approach your destination, the device provides information to help you complete your route.

-  indicates the location of your destination on the map, and a voice prompt announces you are approaching your destination.
- When you approach some destinations, the device automatically prompts you to search for parking. You can select **Yes** to find nearby parking areas ([Parking Near Your Destination, page 11](#)).
- When you stop at your destination, the device automatically ends the route. If the device does not detect your arrival automatically, you can select **Stop** to end your route.

## Parking Near Your Destination

Your device can help you find a parking spot near your destination. When you approach some destinations, the device automatically prompts you to search for parking.

- 1 Select an option:
  - When the device prompts you, select **Yes** to search for nearby parking.
  - If the device does not prompt you, select **Q > Categories > Parking**, and select **📍 > My Destination**.
- 2 Select **Filter Parking**, and select one or more categories to filter parking by availability, type, price, or payment methods (optional).  
**NOTE:** Detailed parking data is not available in all areas or for all parking locations.
- 3 Select a parking location, and select **Go! > Add As Next Stop**.



The device guides you to the parking area.

## Changing Your Active Route

### Adding a Location to Your Route

Before you can add a location to your route, you must be navigating a route (*Starting a Route, page 9*).

You can add locations to the middle or end of your route. For example, you can add a fuel station as the next destination in your route.

- 1 From the map, select  > .
- 2 Search for a location.
- 3 Select a location.
- 4 Select **Go!**.
- 5 Select an option:
  - To add the location as the next destination in your route, select **Add As Next Stop**.
  - To add the location to the end of your route, select **Add As Last Stop**.
  - To add the location and edit the order of destinations in your route, select **Add to Active Route**.



The device re-calculates the route to include the added location and guides you to the destinations in order.

### Shaping Your Route

Before you can shape your route, you must start a route (*Starting a Route, page 9*).

You can manually shape your route to change its course. This allows you to direct the route to use a certain road or go through a certain area without adding a destination to the route.

- 1 Touch anywhere on the map.
- 2 Select .
- The device enters route shaping mode.
- 3 Select a location on the map.

**TIP:** You can select  to zoom in on the map and select a more precise location.  
The device recalculates the route to travel through the selected location.
- 4 If necessary, select an option:
  - To add more shaping points to the route, select additional locations on the map.
  - To remove a shaping point, select .
- 5 When you are finished shaping the route, select **Go!**.

### Taking a Detour



You can take a detour for a specified distance along your route or detour around specific roads. This is useful if you encounter construction zones, closed roads, or poor road conditions.

- 1 From the map, select  > **Edit Route**.
- 2 Select an option:
  - To detour your route for a specific distance, select **Detour by Distance**.
  - To detour around a specific road on the route, select **Detour by Road**.

### Changing the Route Calculation Mode

- 1 Select **Calculation Mode**.
- 2 Select an option:
  - Select **Faster Time** to calculate routes that are faster to drive but can be longer in distance.
  - Select **Off Road** to calculate point-to-point routes (without roads).
  - Select **Shorter Distance** to calculate routes that are shorter in distance but can take more time to drive.

## Stopping the Route

- From the map, select  > .
- From the notification bar, swipe down, and select  in the **Garmin Navigation** notification.

## Using Suggested Routes

Before you can use this feature, you must save at least one location and enable the travel history feature ([Device Settings, page 49](#)).

Using the myTrends™ feature, your device predicts your destination based on your travel history, the day of the week, and the time of day. After you have driven to a saved location several times, the location may appear in the navigation bar on the map, along with the estimated time of travel, and traffic information.

Select the navigation bar to view a suggested route to the location.

## Avoiding Delays, Tolls, and Areas

### Avoiding Traffic Delays on Your Route

Before you can avoid traffic delays, you must be receiving traffic information ([Receiving Traffic Data Using a Traffic Receiver, page 37](#)).

By default, the device optimizes your route to avoid traffic delays automatically. If you have disabled this option in the traffic settings ([Traffic Settings, page 48](#)), you can view and avoid traffic delays manually.

- 1 While navigating a route, select  > **Traffic**.
- 2 Select **Alternate Route**, if available.
- 3 Select **Go!**.

### Avoiding Toll Roads

Your device can avoid routing you through areas that require tolls, such as toll roads, toll bridges, or congestion areas. The device may still include a toll area in your route if no other reasonable routes are available.

- 1 Select  > **Navigation** > **Route Preferences**.
- 2 Select an option:  
**NOTE:** The menu changes based on your area and the map data on your device.
  - Select **Toll Roads**.
  - Select **Tolls and Fees** > **Toll Roads**.
- 3 Select an option:
  - To be asked each time before routing through a toll area, select **Always Ask**.
  - To always avoid tolls, select **Avoid**.
  - To always allow tolls, select **Allow**.
- 4 Select **Save**.

### Avoiding Toll Stickers

If the map data on your device contains detailed toll sticker information, you can avoid or allow roads that require toll stickers for each country.

**NOTE:** This feature is not available in all areas.

- 1 Select  > **Navigation** > **Route Preferences** > **Tolls and Fees** > **Toll Stickers**.
- 2 Select a country.
- 3 Select an option:
  - To be asked each time before routing through an area that requires toll stickers, select **Always Ask**.
  - To always avoid roads that require toll stickers, select **Avoid**.
  - To always allow roads that require toll stickers, select **Allow**.
- 4 Select **Save**.

## Avoiding Road Features

- 1 Select  > **Navigation** > **Route Preferences** > **Avoidances**.
- 2 Select the road features to avoid on your routes, and select **OK**.

## Avoiding Environmental Zones

Your device can avoid areas with environmental or emissions restrictions that may apply to your vehicle. This option applies to the vehicle type in the active vehicle profile ([Vehicle Profiles, page 7](#)).

- 1 Select  > **Navigation** > **Route Preferences** > **Environmental Zones**.
- 2 Select an option:
  - To be asked each time before routing through an environmental zone, select **Always Ask**.
  - To always avoid environmental zones, select **Avoid**.
  - To always allow environmental zones, select **Allow**.
- 3 Select **Save**.

## Custom Avoidances

Custom avoidances allow you select specific areas or sections of road to avoid. When the device calculates a route, it avoids these areas and roads unless no other reasonable route is available.

### Avoiding a Road



- 1 Select  > **Navigation** > **Route Preferences** > **Custom Avoidances**.
- 2 If necessary, select **Add Avoidance**.
- 3 Select **Add Avoid Road**.
- 4 Select the starting point of the section of road to avoid, and select **Next**.
- 5 Select the ending point of the road section, and select **Next**.
- 6 Select **Done**.

### Avoiding an Area



- 1 Select  > **Navigation** > **Route Preferences** > **Custom Avoidances**.
- 2 If necessary, select **Add Avoidance**.
- 3 Select **Add Avoid Area**.
- 4 Select the upper-left corner of the area to avoid, and select **Next**.
- 5 Select the lower-right corner of the area to avoid, and select **Next**.  
The selected area is shaded on the map.
- 6 Select **Done**.

### Disabling a Custom Avoidance

You can disable a custom avoidance without deleting it.

- 1 Select  > **Navigation** > **Route Preferences** > **Custom Avoidances**.
- 2 Select an avoidance.
- 3 Select  > **Disable**.

### Deleting Custom Avoidances

- 1 Select  > **Navigation** > **Route Preferences** > **Custom Avoidances** > .
- 2 Select an option:
  - To delete all custom avoidances, select **Select All** > **Delete**.
  - To delete one custom avoidance, select the avoidance, and select **Delete**.

# Finding and Saving Locations

The maps loaded in your device contain locations, such as restaurants, hotels, auto services, and detailed street information. The **Q** menu helps you find your destination by providing several methods to browse, search, and save this information.

- Enter search terms to quickly search all location information (*Finding a Location Using the Search Bar, page 18*).
- Browse or search pre-loaded points of interest by category (*Points of Interest, page 15*).
- Search and check into Foursquare® points of interest (*Searching Foursquare Points of Interest, page 17*).
- Use search tools to find specific locations, such as addresses, intersections, or geographic coordinates (*Search Tools, page 21*).
- Search near a different city or area (*Changing the Search Area, page 20*).
- Save your favorite locations to find them quickly in the future (*Saving Locations, page 23*).
- Return to recently found locations (*Viewing Recently Found Locations, page 22*).

## Points of Interest

A point of interest is a place that you may find useful or interesting. Points of interest are organized by category and can include popular travel destinations such as gas stations, restaurants, hotels, and entertainment venues.

## Navigating to a Garmin Explore Location

Before you can navigate to a Garmin Explore location, you must add one or more locations to your Garmin Explore account.

- 1 Select **Q** > **Explore**.
- 2 Select a category.
- 3 Select a location.
- 4 Select an option.
  - If you want to navigate to the location using turn-by-turn street guidance, select **Go!**.
  - If you want to view the location using the Garmin Explore app, select .

## Finding a Location by Category

- 1 Select **Q**.
- 2 Select a category, or select **Categories**.
- 3 If necessary, select a subcategory.
- 4 Select a location.

## Searching Within a Category

After you have performed a search for a point of interest, certain categories may display a Quick Search list that shows the last four destinations you selected.

- 1 Select **Q** > **Categories**.
- 2 Select a category.
- 3 Select an option:
  - Select a destination from the quick search list on the right side of the screen.  
The quick search list provides a list of recently found locations in the selected category.
  - Select a subcategory, if necessary, and select a destination.

## Finding Campgrounds

Select **Q** > **All Campgrounds**.

## Finding RV Parks

**NOTE:** This feature is not available in all areas.

You can search for RV parks based on the amenities available.

- 1 Select **Q** > **PlanRV Parks**.
- 2 If necessary, select **Filter by Amenities**, select one or more amenities, and select **Save**.
- 3 Select a location.

## Finding Ultimate Campgrounds Points of Interest

**NOTE:** This feature is not available in all areas.

Your device includes Ultimate Campgrounds points of interest, which allow you to find public campgrounds near your location.

- 1 Select **Q** > **Ultimate Public Campgrounds**.
- 2 If necessary, select **Search Filters**, select one or more search filters, and select **Search**.
- 3 Select a location.

## Finding RV Services

**NOTE:** This feature is not available in all areas.

You can find nearby locations that offer repair, towing, and other services for RVs.

Select **Q** > **PlanRV Services**.

## Finding National Parks

Device models that include maps for North America or the United States also include detailed information for national parks in the United States. You can navigate to a national park or to a location within a national park.

- 1 Select **Q** > **National Parks**.  
A list of national parks appears, with the nearest park at the top.
- 2 Select **Search**, and enter all or part of the park name to narrow the results (optional).
- 3 Select a national park.  
A list of categories for locations of features and amenities within the park appears below the park name.
- 4 Select an option:
  - To start navigating to the park, select **Go!**.
  - To view more park information or explore the park features and amenities, select **i**.
  - To quickly find a location within the park, select a category from the list below the park name, and select a location.

## Exploring National Park Features and Amenities

On North American product models, you can explore detailed information about the features and amenities available inside a national park, and navigate to specific locations in the park. For example, you can find campgrounds, landmarks, visitor centers, and popular attractions.

- 1 From the location search results, select a national park, and select **i**.
- 2 Select **Explore this Park**.  
A list of categories for park features and amenities appears.
- 3 Select a category.
- 4 Select a location, and select **Go!**.

## Finding iOverlander™ Points of Interest

### NOTICE

You are responsible for understanding and complying with any applicable regulations associated with campsites and points of interest.



Your device includes iOverlander points of interest, which allow you to find points of interest useful for overlanding, such as camp sites, repair services, and lodging.

- 1 Select  > **iOverlander**.
- 2 Select a category.
- 3 Select a location.

## Finding HISTORY® Points of Interest

**NOTE:** This feature is not available on all product models or for all map regions.

Your device includes HISTORY points of interest, which allow you to find and learn about historically significant locations and attractions, such as historic buildings, monuments, museums, and notable locations of historic events.

- 1 Select  > **History®**.
- 2 Select a category.
- 3 Select a location.
- 4 Select  to view a photo and a short summary of the location's history.

## Foursquare

Foursquare is a location-based social network. Your device includes pre-loaded Foursquare points of interest, which are indicated by the Foursquare logo in your location search results.

### Searching Foursquare Points of Interest

You can search for Foursquare points of interest loaded on your device.

Select  > **Foursquare**.

## TripAdvisor®

Your device includes TripAdvisor points of interest and ratings. TripAdvisor ratings appear automatically in the search results list for applicable points of interest. You can also search for nearby TripAdvisor points of interest and sort by distance or popularity.



### Finding TripAdvisor Points of Interest

- 1 Select  > **TripAdvisor**.
- 2 Select a category.  
A list of nearby TripAdvisor points of interest for the category appears.
- 3 Select **Sort Results** to sort the search results by distance or popularity (optional).

## Navigating to Points of Interest Within a Venue

**NOTE:** This feature may not be available in all areas or for all product models.

You can create a route to a point of interest (POI) within a larger venue, such as a store in a shopping mall or a specific terminal in an airport.

- 1 Select  > **Search**.
- 2 Select an option:
  - To search for the venue, enter the name or address of the venue, select , and go to step 3.
  - To search for the POI, enter the name of the POI, select , and go to step 5.
- 3 Select the venue.  
A list of categories appears below the venue, such as restaurants, car rentals, or terminals.
- 4 Select a category.
- 5 Select the POI, and select **Go!**.

The device creates a route to the parking area or venue entrance closest to the POI. When you arrive at the destination, a checkered flag indicates the recommended parking area. A labeled point indicates the location of the POI within the venue.

## Exploring a Venue



**NOTE:** This feature may not be available in all areas or for all product models.

You can view a list of all points of interest located within each venue.

- 1 Select a venue.
- 2 Select  > **Explore this Venue**.



## Finding a Location Using the Search Bar

You can use the search bar to search for locations by entering a category, brand name, address, or city name.

- 1 Select .
- 2 Select **Search** in the search bar.
- 3 Enter all or part of the search term.  
Suggested search terms appear below the search bar.
- 4 Select an option:
  - To search for a type of business, enter a category name (for example, "movie theaters").
  - To search for a business name, enter all or part of the name.
  - To search for an address near you, enter the house number and street name.
  - To search for an address in another city, enter the house number, street name, city, and state.
  - To search for a city, enter the city and state.
  - To search for coordinates, enter latitude and longitude coordinates.
- 5 Select an option:
  - To search using a suggested search term, select the term.
  - To search using the text you entered, select .
- 6 If necessary, select a location.

## Finding an Address

**NOTE:** The order of the steps may change depending on the map data loaded on your device.





- 1 Select .
- 2 If necessary, select  to search near a different city or area.
- 3 Select **Address**.
- 4 Follow the on-screen instructions to enter address information.
- 5 Select the address.



## Location Search Results

By default, the location search results appear in a list, with the nearest location at the top. You can scroll down to view more results.



①	Select a location to view the option menu.
② 	Select to view detailed information about the selected location.
③ 	Select to view the selected location in the Garmin Explore app.
④ 	Select to view alternate routes to the locations.
⑤ 	Select to start navigating to the location using the recommended route.
⑥ 	Select to view the search results on the map.

## Location Search Results on the Map

You can view the results of a location search on the map instead of in a list.



From the location search results, select . The nearest location appears at the center of the map, and basic information about the selected location appears at the bottom of the map.



①	Drag the map to view additional search results.
②	Additional search results. Select to view another location.
③	Selected location summary. Select to view detailed information about the selected location.
④ Go!	Select to start navigating to the location using the recommended route.
⑤ 	Select to view the search results in a list.



## Changing the Search Area

By default, the device searches for locations near your current location. You can also search other areas, such as near your destination, near another city, or along your active route.

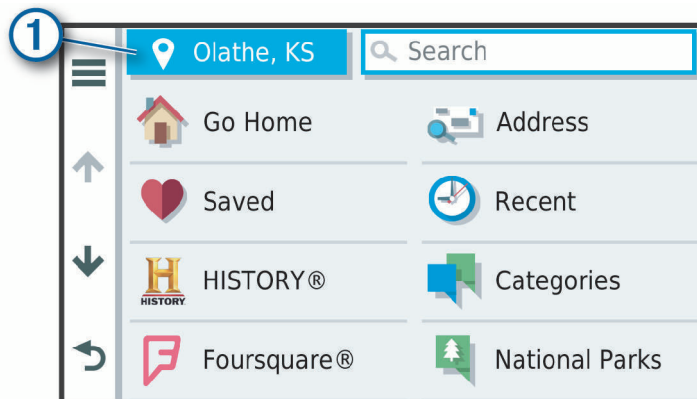
- 1 Select .
- 2 Select  next to the current search area ①.



- 3 Select a search area.
- 4 If necessary, follow the on-screen instructions to select a specific location.

The selected search area appears next to . When you search for a location using any of the options in the  menu, the device suggests locations near this area first.

## Custom Points of Interest

Custom POIs are customized points on the map. They can contain alerts that let you know if you are near a designated point or if you are traveling faster than a specified speed.

### Installing POI Loader

You can create or download custom POI lists on your computer and install them on your device using POI Loader software.

- 1 Go to [www.garmin.com/poiloader](http://www.garmin.com/poiloader).
- 2 Follow the on-screen instructions.

### Finding Custom POIs

Before you can find custom POIs, you must load custom POIs on your device using the POI Loader software (*Installing POI Loader, page 21*).

- 1 Select **Q** > **Categories**.
- 2 Scroll to the Other Categories section, and select a category.

## Parking

Your Overlander device includes detailed parking data, which can help you find nearby parking based on the likelihood of available parking spots, type of parking area, price, or accepted payment methods.

### Finding Parking Near Your Current Location

- 1 Select **Q** > **Categories** > **Parking**.
- 2 Select **Filter Parking**, and select one or more categories to filter parking by availability, type, price, or payment methods (optional).

**NOTE:** Detailed parking data is not available in all areas or for all parking locations.

- 3 Select a parking location.
- 4 Select **Go!**.

### Understanding Parking Colors and Symbols

Parking locations that include detailed parking data are color-coded to show the likelihood of finding parking. Symbols indicate the type of parking available (street or lot), relative pricing information, and payment type.

You can view the legend for these colors and symbols on the device.

From the parking search results, select **i**.

## Search Tools

Search tools allow you to search for specific types of locations by responding to on-screen prompts.

### Finding an Intersection

You can search for an intersection or junction between two streets, highways, or other roads.



- 1 Select **Q** > **Categories** > **Intersections**.
- 2 Follow the on-screen instructions to enter street information.
- 3 Select the intersection.

### Finding a City

- 1 Select **Q** > **Cities**.
- 2 Select an option:
  - Select a city from the list of nearby cities.
  - To search near another location, select **📍** (*Changing the Search Area, page 20*).
  - To search for a city by name, select **Search**, enter a city name, and select **Q**.

## Finding a Location Using Coordinates

You can find a location using latitude and longitude coordinates.

- 1 Select  > **Coordinates**.
- 2 If necessary, select  and change the coordinate format or datum.
- 3 Enter the latitude and longitude coordinates.
- 4 Select **View on Map**.

## Viewing Recently Found Locations

Your device stores a history of the last 50 locations you have found.

Select  > **Recent**.

## Clearing the List of Recently Found Locations

Select  > **Recent** >  > **Clear** > **Yes**.

## Viewing Current Location Information

You can use the Where Am I? page to view information about your current location. This feature is helpful if you need to tell emergency personnel your location.

From the map, select the vehicle.

## Finding Emergency Services and Fuel

You can use the Where Am I? page to find the nearest hospitals, police stations, and fuel stations.

- 1 From the map, select the vehicle.
- 2 Select **Hospitals, Police Stations, Fuel, or Roadside Assist.**  
**NOTE:** Some service categories are not available in all areas.  
A list of locations for the selected service appears, with the nearest locations at the top.
- 3 Select a location.
- 4 Select an option:
  - To navigate to the location, select **Go!**.
  - To view the phone number and other location details, select .

## Getting Directions to Your Current Location

If you need to tell another person how to get to your current location, your device can give you a list of directions.

- 1 From the map, select the vehicle.
- 2 Select  > **Directions to Me**.
- 3 Select a starting location.
- 4 Select **Select**.



## Adding a Shortcut

You can add shortcuts to the Where To? menu. A shortcut can point to a location, a category, or a search tool.

The Where To? menu can contain up to 36 shortcut icons.

- 1 Select  > **Add Shortcut**.
- 2 Select an item.

## Removing a Shortcut

- 1 Select  >  > **Remove Shortcut(s)**.
- 2 Select a shortcut to remove.
- 3 Select the shortcut again to confirm.
- 4 Select **Done**.

## Saving Locations



### Saving a Location

- 1 Search for a location (*Finding a Location by Category, page 15*).
- 2 From the search results, select a location.
- 3 Select  > **Save**.
- 4 Enter a name, and select **Done**.

### Saving Your Current Location

- 1 From the map, select the vehicle icon.
- 2 Select **Save**.
- 3 Enter a name, and select **Done**.
- 4 Select **OK**.



### Editing a Saved Location

- 1 Select  > **Saved**.
- 2 If necessary, select a category.
- 3 Select a location.
- 4 Select .
- 5 Select  > **Edit**.
- 6 Select an option:
  - Select **Name**.
  - Select **Phone Number**.
  - Select **Categories** to assign categories to the saved location.
  - Select **Change Map Symbol** to change the symbol used to mark the saved location on a map.
- 7 Edit the information.
- 8 Select **Done**.

### Assigning Categories to a Saved Location



You can add custom categories to organize your saved locations.

**NOTE:** Categories appear in the saved locations menu after you have saved at least 12 locations.

- 1 Select  > **Saved**.
- 2 Select a location.
- 3 Select .
- 4 Select  > **Edit** > **Categories**.
- 5 Enter one or more category names, separated by commas.
- 6 If necessary, select a suggested category.
- 7 Select **Done**.





## Deleting a Saved Location

**NOTE:** Deleted locations cannot be recovered.

- 1 Select  > **Saved**.
- 2 Select  > **Delete Saved Places**.
- 3 Select the box next to the saved locations to delete, and select **Delete**.

## Using the Street Map

You can use the street map to navigate a route (*Your Route on the Map, page 10*) or to view a map of your surroundings when no route is active.

- 1 Select **Drive**.
- 2 Touch anywhere on the map.
- 3 Select an option:
  - Drag the map to pan left, right, up, or down.
  - To zoom in or out, select  or .
  - To switch between North Up and 3-D views, select .
  - To filter the displayed points of interest by category, select .
  - To start a route, select a location on the map, and select **Go!** (*Starting a Route by Using the Map, page 9*).

## Map Tools

Map tools provide quick access to information and device functions while you view the map. When you activate a map tool, it appears in a panel at the edge of the map.

**Stop:** Stops navigation of the active route.

**Edit Route:** Allows you to take a detour or skip locations in your route (*Changing Your Active Route, page 12*).

**Mute:** Mutes the master volume.

**Cities Ahead:** Shows upcoming cities and services along your active route or along a highway.

**Up Ahead:** Shows upcoming locations along the route or the road on which you are traveling (*Up Ahead, page 24*).

**Elevation:** Displays elevation changes ahead.

**Traffic:** Displays traffic conditions along your route or in your area (*Viewing Upcoming Traffic, page 27*). This feature is not available in all areas or for all device models.

**Trip Data:** Displays customizable trip data, such as speed or mileage (*Viewing Trip Data from the Map, page 27*).

**Turns:** Displays a list of upcoming turns in your route (*Viewing Turns and Directions, page 11*).

**Phone:** Displays a list of recent phone calls from your connected phone, and displays in-call options while a phone call is active (*Using In-Call Options, page 36*).

## Viewing a Map Tool

- 1 From the map, select .
- 2 Select a map tool.



The map tool appears in a panel at the edge of the map.
- 3 When you are done using the map tool, select .

## Up Ahead

The Up Ahead tool provides information about upcoming locations along your route or the road on which you are traveling. You can view upcoming points of interest, such as restaurants, fuel stations, or rest areas. When traveling on a highway, you can also view information and available services for upcoming exits and cities, similar to the information on highway road signs.

You can customize three categories to show in the Up Ahead tool.



## Viewing Upcoming Locations

- 1 From the map, select  > **Up Ahead**.
- 2 Select an option:
  - To view the next upcoming location in each category, select , if necessary.
  - To view information and available services for upcoming highway exits or cities, select .

**NOTE:** This option is available only while you are traveling on a highway or when your route includes a highway.
- 3 Select an item to view a list of locations for that category, exit, or city.

## Customizing the Up Ahead Categories

You can change the location categories that appear in the Up Ahead tool.

- 1 From the map, select  > **Up Ahead**.
- 2 Select a category.
- 3 Select .
- 4 Select an option:
  - To move a category up or down in the list, select and drag the arrow next to the category name.
  - To change a category, select the category.
  - To create a custom category, select a category, select **Custom Search**, and enter the name of a business or category.
- 5 Select **Save**.

## Warning and Alert Symbols

### **WARNING**







Entering your vehicle profile characteristics does not guarantee that your vehicle's characteristics will be accounted for in all route suggestions or that you will receive the warning icons in all cases. Limitations may exist in the map data such that your device cannot account for these restrictions or road conditions in all cases. Always defer to all posted road signs and road conditions when making driving decisions.

Warning and alert symbols may appear on the map or in route directions to alert you to potential hazards and road conditions.

## Restriction Warnings

	Height
	Weight
	Axle Weight
	Length
	Width
	No Trucks Allowed
	No Trailers Allowed
	No Hazardous Materials Allowed
	No Flammables Allowed
	No Water Pollutants Allowed
	No Left Turn
	No Right Turn
	No U Turn

## Road Condition Warnings

	Risk of grounding
	Lateral wind
	Narrow road
	Sharp curve
	Steep down hill
	Tree overhang



## Alerts

	Weigh station
	Road not verified for trucks

## Trip Information

### Viewing Trip Data from the Map

Before you can view trip data on the map, you must add the tool to the map tools menu.

From the map, select  > **Trip Data**.

### Customizing the Trip Data Fields

Before you can customize the data that appears in the trip data map tool, you must add the trip data tool to the map tools menu.

1 From the map, select  > **Trip Data**.

2 Select a trip data field.

3 Select an option.

The new trip data field appears in the trip data map tool.

### Viewing the Trip Information Page

The trip information page displays your speed and provides statistics about your trip.

**NOTE:** If you make frequent stops, leave the device turned on, so it can accurately measure elapsed time during the trip.

From the map, select **Speed**.

### Viewing the Trip Log

Your device keeps a trip log, which is a record of the path you have traveled.

1 Select  > **Navigation** > **Map & Vehicle** > **Map Layers**.

2 Select the **Trip Log** check box.

### Resetting Trip Information

1 From the map, select **Speed**.

2 Select  > **Reset Field(s)**.

3 Select an option:

- When not navigating a route, select **Select All** to reset every data field except the speedometer, on the first page.
- Select **Reset Trip Data** to reset the information on the trip computer.
- Select **Reset Max. Speed** to reset the maximum speed.
- Select **Reset Trip B** to reset the odometer.

### Viewing Upcoming Traffic

Before you can use this feature, your device must be receiving traffic data ([Traffic](#), page 37).

You can view traffic incidents coming up along your route or along the road on which you are traveling.



1 While navigating a route, select  > **Traffic**.

The nearest upcoming traffic incident appears in a panel on the right side of the map.



2 Select the traffic incident to view additional details.

## Viewing Traffic on the Map

The traffic map shows color-coded traffic flow and delays on nearby roads.

- 1 From the main menu, select  >  > **Traffic**.
- 2 If necessary, select  > **Legend** to view the legend for the traffic map.

## Searching for Traffic Incidents

- 1 From the main menu, select  >  > **Traffic**.
- 2 Select  > **Incidents**.
- 3 Select an item in the list.
- 4 If there is more than one incident, use the arrows to view additional incidents.

## Customizing the Map

### Customizing the Map Layers

You can customize which data appear on the map, such as icons for points of interest and road conditions.

- 1 Select  > **Navigation** > **Map & Vehicle** > **Map Layers**.
- 2 Select the check box next to each layer you want to show on the map.

### Changing the Map Data Field

- 1 From the map, select a data field.  
**NOTE:** You cannot customize Speed.
- 2 Select a type of data to display.

### Changing the Map Perspective

- 1 Select  > **Navigation** > **Map & Vehicle** > **Driving Map View**.
- 2 Select an option:
  - Select **Track Up** to display the map in two dimensions (2-D), with your direction of travel at the top.
  - Select **North Up** to display the map in 2-D with north at the top.
  - Select **3-D** to display the map in three dimensions.

# Off-Road Navigation

## Garmin Explore

The Garmin Explore website and mobile app allow you to plan trips and use cloud storage for your waypoints, routes, and tracks. Garmin Explore offers advanced planning both online and offline, allowing you to share and sync data with your device. You can use the included app to download maps for offline access, and then navigate anywhere without using your mobile data service.

The Garmin Explore app is included on your device. You can also download the Garmin Explore app from the app store on your smartphone, or you can go to [explore.garmin.com](https://explore.garmin.com).



- |   |   |
|---|---|
| ① | Select to open the map settings menu.                           |
| ② | Select to add waypoints and create routes.                      |
| ③ | Select to open the Garmin Drive™ app for street navigation.     |
| ④ | Select to change the map orientation.                           |
| ⑤ | Select to zoom in the map.                                      |
| ⑥ | Select to zoom out the map.                                     |
| ⑦ | Select to view the map.   |
| ⑧ | Select to manage waypoints, tracks, routes, and activities.     |
| ⑨ | Select to view Garmin Explore account information and settings. |

## Logging In to a Garmin Explore Account



The first time you use your device, you are prompted to log in to a Garmin Explore account.

- 1 Select **Explore**.
- 2 Read and agree to the End User License Agreement.  
**NOTE:** If you do not agree with the license terms, you can select  to exit the Garmin Explore app. You cannot use the Garmin Explore app until you accept the license agreements.
- 3 Select **Next**.
- 4 Select an option:
  - If you want to sync your device data with your Garmin Explore account automatically, select **Sync My Data**.
  - If you want to create a Garmin Explore account without synchronizing data, select **Not Now**.
- 5 Select an option:
  - If you have a Garmin Explore account, enter your email address and password, and select **Next**.
  - If you do not have a Garmin Explore account, select **Create One**.
- 6 Follow the on-screen instructions to create or log in to your Garmin Explore account.



## Map

### Downloading Garmin Explore Maps

Before you can download Garmin Explore maps, you must connect to a wireless network ([Connecting to a Wireless Network, page 48](#)).

- 1 From the **Explore** app, select  > **Maps** > **Download Maps**.  
A list of maps for your location appears.
- 2 Select **Show More Map Types** to view additional map types (optional).
- 3 Select a map type, and select .
- 4 If necessary, select **Select Region** or **Select Waypoint** to download maps for a different region or waypoint location.

### Updating Garmin Explore Maps

- 1 From the **Explore** app, select  > **Maps** > **Map Updates**.  
A list of map updates appears.
- 2 Select an option:
  - To download a specific map, select .
  - To download all map updates, select **Update All**.

### Filtering Map Data

- 1 Select **Map** > .
- 2 Select an option:
  - To filter collections map data, select **Collections**, and select an option.
  - To filter activities map data, select **Activities**, and select an option.

### Garmin Explore Map Settings

From the Explore app, select Account.

**Data Fields:** Adds data fields for heading, elevation, speed, and GPS coordinates to the map.

**Scale Bar:** Adds a distance scale to the map.

**Zoom Controls:** Enables or disables the zoom controls on the map.

**Units:** Sets the units of measure.

## Creating a Waypoint

You can use the Garmin Explore app to create and save waypoints. You can use your device to navigate to waypoint locations.

- 1 Select **Map**.
- 2 Select an option.
  - To create a waypoint at your current location, select **+** > **Add Waypoint**.
  - To create a waypoint in another location on the map, touch a location on the map, and select **Add Waypoint**.
- 3 If necessary, select **Select to edit notes**, and add notes about the location.



## Creating a Route

- 1 From the **Explore** app, select **Map** > **+** > **Add Route**.
- 2 Select a starting location.
- 3 Select additional points to create a line for your route.
- 4 If necessary, select **Edit**, select a point, and move it.
- 5 If necessary, select **Delete**, and select a point.
- 6 Select **Save**.

## Library

### Viewing Your Library

- 1 From the **Explore** app, select **Library**.
- 2 Select a data type.
- 3 Select an item to view the details.

**TIP:** You can select  to view the elevation profile for a track, route, or activity.
- 4 If necessary, select  to download maps for the area.

### Navigating to a Saved Location

You can start a route to a saved waypoint, track, or route in your Garmin Explore library.

- 1 From the **Explore** app, select **Library**.
- 2 Select **Waypoints**, **Tracks**, or **Routes**.
- 3 Select a location.
- 4 Select .

### Creating a Collection

- 1 Select **Library** > **New Collection**.
- 2 Enter a collection name.
- 3 Select the collection, and select **Add**.
- 4 Select a data type.
- 5 Select one or more items, and select **Add**.

### Viewing Collections

- 1 Select **Library**.
- 2 Select a collection.
- 3 Select a data type.
- 4 Select an item to view the details.
- 5 If necessary, select  to download maps for the area.

## Synchronizing Garmin Explore Account Data

Before you can synchronize account data, you must connect to a Wi-Fi network.

You can synchronize data, such as waypoints, routes, and activities with your Garmin Explore account. This can be helpful to keep your data available on each of your compatible devices. Your device periodically synchronizes data with your account automatically. You can also synchronize data manually at any time.

- 1 From the **Explore** app, select **Account**.
- 2 Verify the **Sync User Data** option is selected.
- 3 Select .

## Importing GPX Files with a Memory Card

You can import data, such as waypoints, routes, and tracks in .gpx file format from a compatible microSD® card.

- 1 Insert a compatible microSD card containing one or more .gpx files into the memory card slot on your device ([Installing a Memory Card for Maps and Data, page 63](#)).
- 2 On your Overlander device, select **Explore > Library > Import to Explore > Memory Card**.
- 3 Select one or more .gpx files, and select **SELECT**.
- 4 Select an option:
  - To import the files as unorganized locations, select **Import as Unorganized**.
  - To import the files to a collection, select a collection.
- 5 Select **IMPORT**.

## Exporting GPX Files with a Memory Card

You can export data, such as waypoints, routes, and tracks to a compatible microSD card.

- 1 Insert a compatible microSD card into the memory card slot on your device ([Installing a Memory Card for Maps and Data, page 63](#)).
- 2 On your Overlander device, select **Explore > Library > Export from Explore > Memory Card**.
- 3 Select one or more waypoints, routes, or tracks.
- 4 Select **EXPORT**.

## Recording Tracks



Tracking records your path. When you start tracking, your device logs your location and updates the track line. If your device is paired with an inReach® device, your device records track points and transmits them over the satellite network at the specified send interval.

- 1 Select  >  > **Track Recorder**.
- 2 Select **Start**.

## Changing Tracking Intervals



Before you can change tracking intervals, you must pair your device with a compatible inReach device.

You can change the tracking intervals to determine how often your device logs and transmits track points.

- 1 Select  >  > **Track Recorder** > .
- 2 Select an option:
  - To change the frequency at which the device records a track point and transmits it over the satellite network, select **Send Interval**.
  - To change the frequency at which the device logs your location and updates the track line, select **Log Interval**.
- 3 Select an interval.

**TIP:** You can select Off to disable sending or logging features.

## Stopping Tracking

- 1 Select  >  > **Track Recorder** > **Stop**.
- 2 Select an option:
  - To continue recording a track, select **Resume Recording**.
  - To save a track for viewing in Garmin Explore, select **Save Track to Garmin Explore**.
  - To discard the track, select **Discard Track**.

## Pitch and Roll



### **WARNING**

The Pitch and Roll application is intended to show vehicle angles based on calibrated measurements only. You are responsible for calibrating the device. Changes to the position of the device after calibration may affect the accuracy of its measurements. Measured values are suggestions only based on your input into the device. Take readings often and carefully, and allow the readings to stabilize after significant changes in environmental conditions. Always allow a margin of safety for changing conditions and reading errors. Failure to account for your vehicle and your environment could cause an incident resulting in death or serious injury.

The device alerts you if your vehicle pitches or rolls at an angle that could affect the vehicle's stability.

## Calibrating Pitch and Roll

You can set the angle of your vehicle to zero at any time.

- 1 Park your vehicle on a flat, level surface.
- 2 Adjust the position of your device in the mount so you can comfortably view the screen.
- 3 Select  >  > **Pitch and Roll** > **Calibrate**.



The values for pitch and roll reset to 0 degrees.

### **WARNING**



To maintain the best accuracy, you must calibrate pitch and roll each time you reposition your device.

## Adjusting Warning Angles

You can adjust the angles at which the device activates a pitch or roll alert. You are responsible for knowing and setting the correct pitch and roll angle for your vehicle.

- 1 Select  >  > **Pitch and Roll** >  > **Warning Angles**.
- 2 Swipe up or down to adjust the pitch or roll warning angles.
- 3 Select **Accept**.

## Enabling or Disabling Warning Angle Alerts

- 1 Select  >  > **Pitch and Roll** > .
- 2 Select an option:
  - To enable or disable pitch and roll notifications, select **Pitch and Roll Notifications**.
  - To enable or disable audible alerts, select **Audible Alerts**.

## Viewing the Altimeter, Barometer, and Compass

The device contains internal altimeter, barometer, and compass sensors with automatic calibration.

Select  >  > **ABC**.

## Calibrating the Compass

### NOTICE

Calibrate the electronic compass outdoors. To improve heading accuracy, do not stand near metal objects or objects that influence magnetic fields, such as vehicles, electronic devices, buildings, or overhead power lines.

When your device is connected to the magnetic mount, it uses GPS data to determine your compass heading. When you remove the device from the magnetic mount, it uses a built-in compass to show your heading.

Each time you disconnect your device from the magnetic mount, the device prompts you to calibrate the compass. If you experience irregular compass behavior, for example, after moving long distances or after extreme temperature changes, you can manually calibrate the compass to improve accuracy.

- 1 Disconnect the device from the magnetic mount and move away from objects that influence magnetic fields.
- 2 Select  > **Calibrate Compass**.
- 3 Follow the on-screen instructions.

## inReach Remote

The inReach remote function allows you to control your inReach device using your Overlander device. You can send messages, view weather reports, trigger an SOS alert, and more. Go to [buy.garmin.com](http://buy.garmin.com) to purchase an inReach device.

### Connecting an inReach Device





- 1 Bring the inReach device within 3 m (10 ft.) of your Overlander device.
- 2 On your Overlander device, select .
- 3 Select the **Explore** tab.
- 4 Select **inReach**.
- 5 Follow the on-screen instructions on your Overlander device to complete the pairing process.

After the pairing process is complete, the inReach and Overlander devices connect automatically when they are within range.

### Sending an inReach Message

Before you can send an inReach message using your Overlander device, you must pair it with a compatible inReach device ([Connecting an inReach Device, page 34](#)).

You can use your device to send inReach messages to your contacts.

- 1 Select  >  > **inReach** > .
- 2 Select  to add one or more contacts.
- 3 Enter a message.
- 4 Select **Send**.

## SOS

During an emergency, you can contact the GEOS International Emergency Rescue Coordination Center (IERCC) to request help. Pressing the SOS button sends a message to the rescue coordination center, and they notify the appropriate emergency responders of your situation. You can communicate with the rescue coordination center during your emergency while you wait for help to arrive. You should only use the SOS function in a real emergency situation.



## Initiating an SOS Rescue

Before you can initiate an SOS rescue using your Overlander device, you must pair it with a compatible inReach device ([Connecting an inReach Device, page 34](#)).

**NOTE:** While in SOS mode, the inReach device cannot be turned off.

1 Select  >  > **inReach** >  > **SOS**.

2 Slide the **SOS** icon to the right.

3 Wait for the SOS countdown.

The device sends a default message to the emergency response service with details about your location.

4 Reply to the confirmation message from the emergency response service.

Your reply lets the emergency response service know that you are capable of interacting with them during the rescue.

For the first 10 minutes of your rescue, an updated location is sent to the emergency response service every minute. To conserve battery power after the first 10 minutes, an updated location is sent every 10 minutes when moving, and every 30 minutes when stationary.

## Canceling an SOS Rescue

If you no longer need assistance, you can cancel an SOS rescue after it is sent to the emergency response service.

Select **Cancel SOS** > **Cancel SOS**.

Your device transmits the cancellation request. When you receive a confirmation message from the emergency response service, the device returns to normal operation.

# Hands-Free Calling

**NOTE:** While most phones and headsets are supported and can be used, it cannot be guaranteed that a particular phone or headset can be used. All features may not be available for your phone.

Using Bluetooth wireless technology, your device can connect to your mobile phone and wireless headset or helmet to become a hands-free device. To determine whether your device with Bluetooth technology is compatible with your device, go to [www.garmin.com/bluetooth](http://www.garmin.com/bluetooth).

## Pairing Your Phone

Before you can use hands-free calling, you must pair your device with a compatible mobile phone.

1 Place your phone and your Overlander device within 3 m (10 ft.) of each other.

2 On your phone, enable Bluetooth wireless technology, and set your phone to be visible or discoverable to other devices.

For more information, see the owner's manual for your phone.

3 On your Overlander device, select  > **Bluetooth**.

4 Select the toggle switch to turn on Bluetooth technology.

A list of nearby Bluetooth devices appears.

5 Select your phone from the list.

6 If necessary, verify the code displayed on your phone matches the code displayed on your Overlander device.

7 Select **Pair**.

**NOTE:** To view contacts and call logs on your Overlander device, you may need to go to the Bluetooth settings on your phone and enable the contact sharing permission for the paired Overlander device. For more information, see the owner's manual for your phone.





## Tips After Pairing the Devices

- After the initial pairing, the two devices can connect automatically each time you turn them on.
- When your phone is connected to your device, you are ready to receive voice calls.
- When you turn on the device, it tries to connect to the last phone to which it was connected.
- You might need to set your phone to connect to the device automatically when the device is turned on.
- To place phone calls, the contact sharing permission must be enabled for the navigation device in the Bluetooth settings on your phone.
- You should verify the Bluetooth features you want to use are enabled.

## Pairing Additional Bluetooth Devices

- 1 Place your headset or phone and your Bluetooth device within 33 ft. (10 m) of each other.
- 2 On your device, enable Bluetooth wireless technology.
- 3 On your headset or phone, enable Bluetooth wireless technology and make it visible to other Bluetooth devices.
- 4 On your device, select  > **Bluetooth**.  
A list of nearby Bluetooth devices appears.
- 5 Select your headset or phone from the list.
- 6 Select **Pair**.

## Placing a Call

- 1 Select .
- 2 Select an option:
  - To dial a number, select , enter the phone number, and select .
  - To call a recently dialed or received phone number, select , and select a number.
  - To call a contact from your phone book, select  and select a contact.





## Receiving a Call

When you receive a call, select **Answer** or **Dismiss**.

## Using In-Call Options



In-call options appear when you answer a call. Some options may not be compatible with your phone.

**TIP:** If you close the in-call options page, you can open it again by selecting  from the main menu.

- To set up a conference call, select .
- To transfer audio to your phone, select .  
**TIP:** You can use this feature if you want to disconnect the Bluetooth connection and remain on the call, or if you need privacy.
- To use the dial pad, select .  
**TIP:** You can use this feature to use automated systems, such as voice mail.
- To mute the microphone, select .
- To hang up, select .

## Saving a Phone Number as a Preset

You can save up to three contacts as presets on the dial pad. This allows you to quickly call your home phone number, family members, or frequently called contacts.

- 1 Select  > .
- 2 Hold a preset number, such as **Preset 1**.
- 3 Select a contact.



## Disconnecting a Bluetooth Device

You can temporarily disconnect a Bluetooth device without deleting it from the paired devices list. The Bluetooth device can connect to your Overlander device automatically in the future.

- 1 Select  > **Bluetooth**.
- 2 Select the device to disconnect.



## Deleting a Paired Bluetooth Device

You can delete a paired Bluetooth device to prevent it from automatically connecting to your Overlander device in the future. Deleting a paired smartphone also deletes all synced phonebook contacts and call history from your Overlander device.

- 1 Select  > **Bluetooth**.
- 2 Next to the Bluetooth device name, select  > **Forget**.

## Deleting a Paired Phone

You can delete a paired phone to prevent it from automatically connecting to your device in the future.

- 1 Select  > **Bluetooth**.
- 2 Next to the phone name, select  > **Forget**.

# Traffic

### NOTICE

Garmin is not responsible for the accuracy or timeliness of the traffic information.

Your device can provide information about traffic on the road ahead or on your route. You can set your device to avoid traffic when calculating routes, and to find a new route to your destination if a large traffic delay occurs on your active route ([Traffic Settings, page 48](#)). The traffic map allows you to browse the map for traffic delays in your area.

To provide traffic information, your device must be receiving traffic data.

- All product models can receive traffic data using an over-the-air traffic receiver cable accessory ([Receiving Traffic Data Using a Traffic Receiver, page 37](#)). Go to your product page at [garmin.com](http://garmin.com) to find and purchase a compatible traffic receiver cable accessory.

Traffic data is not available in all areas. For information about traffic coverage areas, go to [garmin.com/traffic](http://garmin.com/traffic).

## Receiving Traffic Data Using a Traffic Receiver

### NOTICE

Heated (metallized) windshields could degrade the performance of the traffic receiver.

A traffic receiver receives traffic data from an over-the-air broadcast signal, where available. An over-the-air traffic receiver cable is available as an accessory for all product models. Go to your product page at [garmin.com](http://garmin.com) to find and purchase a compatible traffic receiver cable accessory. Traffic data is not available in all areas.

Connect the device to vehicle power using the traffic receiver cable ([Mounting and Powering the Device in Your Vehicle, page 3](#)).

**NOTE:** The traffic receiver cable has an integrated antenna for the built-in digital traffic receiver. Where available, the digital traffic receiver receives traffic data from FM radio stations using HD Radio™ technology.

When you are within a traffic coverage area, your device can display traffic information and help you avoid traffic delays.

## Enabling Traffic



Before you can enable traffic, you must connect your device to a compatible traffic receiver cable (*Receiving Traffic Data Using a Traffic Receiver, page 37*).

You can enable or disable traffic data.



- 1 Select  > **Navigation** > **Traffic**.
- 2 Select the **Traffic** check box.

## Viewing Traffic on the Map

The traffic map shows color-coded traffic flow and delays on nearby roads.

- 1 From the main menu, select  >  > **Traffic**.
- 2 If necessary, select  > **Legend** to view the legend for the traffic map.

## Searching for Traffic Incidents

- 1 From the main menu, select  >  > **Traffic**.
- 2 Select  > **Incidents**.
- 3 Select an item in the list.
- 4 If there is more than one incident, use the arrows to view additional incidents.

# Voice Command

**NOTE:** Voice command is not available for all languages and regions, and may not be available on all models.



**NOTE:** Voice Activated Navigation may not achieve desired performance when in a noisy environment.

Voice command allows you to use your device by saying words and commands. The voice command menu provides voice prompts and a list of available commands.

## Setting the Wakeup Phrase

The wakeup phrase is a word or phrase you can say to activate voice command. The default wakeup phrase is OK Garmin.

**TIP:** You can reduce the chance of accidental voice command activation by using a strong wakeup phrase.

- 1 Select  >  > **Voice Command** >  > **Wake Up Phrase**.
- 2 Enter a new wakeup phrase.  
The device indicates the strength of the wakeup phrase as you enter the phrase.
- 3 Select **Done**.

## Activating Voice Command

- 1 Say **OK Garmin**.  
The voice command menu appears.
- 2 Say a command from the menu.
- 3 Respond to the voice prompts to complete the search or action.

## Voice Command Tips

- Speak in a normal voice directed at the device.
- Reduce background noise, such as voices, or the radio, to increase the accuracy of the voice recognition.
- Speak commands as they appear on the screen.
- Respond to voice prompts from the device as needed.
- Increase the length of your wakeup phrase to reduce the chance of accidental voice command activation.
- Listen for two tones to confirm when the device enters and exits voice command.

## Starting a Route Using Voice Command

You can say the names of popular, well-known locations.

- 1 Say your wakeup phrase ([Setting the Wakeup Phrase, page 38](#)).
- 2 Say **Find Place**.
- 3 Listen for the voice prompt, and speak the name of the location.
- 4 Say the line number.
- 5 Say **Navigate**.

## Muting Instructions



You can disable the voice prompts for voice command without muting the device.

- 1 Select  >  > **Voice Command** > .
- 2 Select **Mute Instructions** > **Enabled**.

# Using the Apps

## Viewing the Owner's Manual on Your Device

You can view the complete owner's manual on the device screen in many languages.

- 1 Select  > **Help**.  
The owner's manual appears in the same language as the software text ([Setting the Text Language, page 49](#)).
- 2 Select  to search the owner's manual (optional).

## Viewing Previous Routes and Destinations

Before you can use this feature, you must enable the travel history feature ([Device Settings, page 49](#)).

You can view your previous routes and places you have stopped on the map.

Select  > **Where I've Been**.

## Fusion-Link™ Wireless Remote Control App

You can use the Fusion-Link remote control app on your Overlander device to control a compatible Fusion® stereo. You can adjust the volume, change the source, control playback, select and manage radio presets, adjust some stereo settings, and configure DSP profiles on the stereo.

The app communicates with the stereo using a wireless connection to the Overlander device. You must connect your device to the stereo using Bluetooth technology in order to use the app.

If you connect the stereo to a Wi-Fi network, the app can communicate with the stereo using that network, which provides a greater range than a Bluetooth connection.

## Connecting to a Stereo Using Bluetooth

- 1 Enable Bluetooth discoverable mode on your compatible Fusion stereo.
- 2 Turn on your Overlander device, and place the device within 10 m (33 ft.) of the stereo.
- 3 On your Overlander device, select  > **Bluetooth**.
- 4 Select your Fusion stereo from the list of available devices.



## Connecting to a Stereo Using a Wireless Network

You can connect your Overlander device to a compatible Fusion stereo that is connected to the same wireless network.

- 1 Select an option:
  - Connect your Fusion stereo to the vehicle's Ethernet or wireless network.
  - If your Fusion stereo has a built-in wireless network, enable wireless networks in the stereo settings.
- 2 On your Overlander device, select  > **Wi-Fi**.
- 3 Select the same wireless network to which your stereo is connected.
- 4 If necessary, enter a password.

## Music Playback

### Playing Music

- 1 Select  >  > **Fusion Link**.
- 2 Select a stereo from the list.
- 3 If necessary, select a song or station.







### Selecting a Source

- 1 Select the source icon.

The source icon is in the upper-left corner of the stereo screen, and it indicates the source that is currently selected.
- 2 Select a source.



### Playback Controls

The on-screen playback controls may change depending on the source selected.

	Select to pause media playback.
	Select to play media or resume media playback.
	<ul style="list-style-type: none"><li>• Select to skip to the previous track when using an applicable source.</li><li>• Hold to rewind the track when using an applicable source.</li><li>• AM or FM source:<ul style="list-style-type: none"><li>◦ Select to tune to the previous station or preset.</li><li>◦ Hold for faster tuning (manual mode only).</li></ul></li></ul>
	<ul style="list-style-type: none"><li>• Select to skip to the next track when using an applicable source.</li><li>• Hold to fast-forward the track when using an applicable source.</li><li>• AM or FM source:<ul style="list-style-type: none"><li>◦ Select to tune to the next station or preset.</li><li>◦ Hold for faster tuning (manual mode only).</li></ul></li></ul>
	Select to cycle through the tuning modes (auto or manual) and presets. Press and hold to save the current station as a preset.
	Select to increase the volume for the current zone.
	Select to decrease the volume for the current zone.
Gain	On the AUX source, move the slider to increase or decrease the gain.

## Audio Control

### Adjusting the Volume for a Zone

- 1 Select  >  > **Fusion Link** > .
- 2 Move the slider to control the volume for a zone.



### Muting all Connected Stereos

You can quickly mute the audio from this stereo or from all stereos connected to the network.

From any source, select .



The mute symbol appears and audio from this stereo is silenced.

### Adjusting the Tones

- 1 Select  >  > **Fusion Link** >  > **Music**.
- 2 Select a zone.
- 3 Select **Tone**.
- 4 Move the slider bar to adjust the level of each tone.

### Disabling the Loud Setting for a Zone

The Loud setting maintains frequency response at low volumes and increases perceived loudness at high volumes. This setting is enabled by default in all zones.

- 1 Select  >  > **Fusion Link** >  > **Music**.
- 2 Select a zone.
- 3 Select **Loud** to enable or disable the setting.

### Adjusting the Gain for an Auxiliary Device

You can adjust the gain for a connected auxiliary device to achieve a volume level similar to that of other media sources. You can adjust the gain in 1 dB increments.

- 1 Select an auxiliary source.
- 2 Move the slider to increase or decrease the gain.



**NOTE:** To achieve the best audio quality when using a portable media player with a headphone output, it may be necessary to adjust the volume control on the media player, instead of adjusting the gain.

## Speaker Zones

You can group speakers in one area into a speaker zone. This enables you to control the audio level of the zones individually. For example, you could make the audio quieter in the cabin and louder on deck.

You can set the balance, volume limit, tone, subwoofer level, subwoofer frequency, and name for each zone, and configure other zone-specific settings.

### Adjusting the Audio Settings for a Zone

- 1 Select  >  > **Fusion Link** >  > **Music**.
- 2 Select a zone.
- 3 Select **More**.
- 4 Select one or more options:



**NOTE:** Not all options are available for all zones.

- To limit the maximum volume level of this zone, select **VOLUME LIMIT**, and adjust the level.
- To set the subwoofer level for this zone, select **SUB LEVEL**, and adjust the level.
- To adjust the right and left speaker balance of this zone, select **BALANCE**, and adjust the balance.

## Adjusting the Subwoofer Filter

You can use the subwoofer filter setting to control the subwoofer cutoff frequency for each zone, which can enhance the blend of the sound produced by the speakers and the subwoofer. Audio signals above the selected cutoff frequency are not passed to the subwoofer.

**NOTE:** If a DSP setting has been applied to the zone, this setting cannot be changed on the stereo. You can view the DSP setting for the optimal cutoff frequency as calculated by the DSP controller, but you cannot adjust it.

- 1 Select  >  > **Fusion Link** >  > **Music**.
- 2 Select a zone.
- 3 Select **Subwoofer Filter**.
- 4 Select a frequency.

## DSP Settings



Some Fusion stereos feature digital signal processing (DSP). You can select pre-configured DSP settings for Fusion speakers and amplifiers to optimize audio quality.

All DSP settings are configured using the Fusion-Link remote control app.

**NOTE:** This feature is not available for all stereo models.

## Configuring the DSP Settings

You can configure the DSP settings to optimize the sound in each zone that uses Fusion speakers and amplifiers.

- 1 Select  >  > **Fusion Link** >  > **Music**.
- 2 Select a zone.
- 3 Select **DSP Settings**.
- 4 Configure the DSP settings as needed, depending on the models of the Fusion speakers and amplifiers connected to the zone.
- 5 Repeat these steps for each zone.
- 6 After you have finished configuring the DSP settings for all of the zones, select **Send DSP Settings**.

## Presets

You can save your favorite AM stations and FM stations as presets for easy access.



### Saving a Station as a Preset

- 1 With an applicable source selected, tune the stereo to a station or a channel.
- 2 Press and hold .

### Selecting a Preset from a List

- 1 With an applicable source selected, select .
- 2 Select a preset.

### Removing Presets

- 1 With an applicable source selected, select .
- 2 Select .
- 3 Select each preset you want to remove.
- 4 After you have finished removing presets, select .



## Audio Settings

Select  >  > **Fusion Link** > .

**Music:** Enables you to configure the speaker zones.

**Tuner Region:** Sets the region used by the various radio sources.

**Device Name:** Sets a name for this stereo.

**Searching:** Enables Fusion Alpha Search Technology (FAST), which allows you to quickly search for tracks by letter or number. You can set the minimum number of tracks required to enable the FAST menu. FAST searching is available when your device contains more than this number of tracks.



**Update:** Allows you to update the stereo and DSP settings software.

**About:** Shows the software version information for the stereo.

## Speaker Zone Settings

### Setting a Zone Name

You can set a name for a speaker zone to make it easier to identify.

- 1 Select  >  > **Fusion Link** >  > **Music**.
- 2 Select a zone.
- 3 Select **Zone Name**.
- 4 Use the on-screen keyboard to enter a name, and select **OK**.

### Linking Zones



You can link zones 1 and 2 to keep the volume levels synchronized. Adjusting the volume of either of the linked zones affects both zones.

Select  >  > **Fusion Link** >  > **Music** > **Zone 2** > **Link to zone 1**.

**NOTE:** After zones 1 and 2 are linked, you cannot adjust the volume of each zone individually.

### Disabling a Zone

You can disable an unused zone and remove it from the audio level pages. When a zone is disabled, you cannot change any of the settings for that zone. You can disable zones 3 and 4 only.

- 1 Select  >  > **Fusion Link** >  > **Music**.
- 2 Select a zone.
- 3 Select **Zone Enabled**.



### Disabling the Internal Amplifiers

If you do not connect speakers directly to zones 1 and 2, you can disable the internal amplifiers to reduce power consumption.

- 1 Select  >  > **Fusion Link** >  > **General**.
- 2 Select **Internal Amplifiers**.

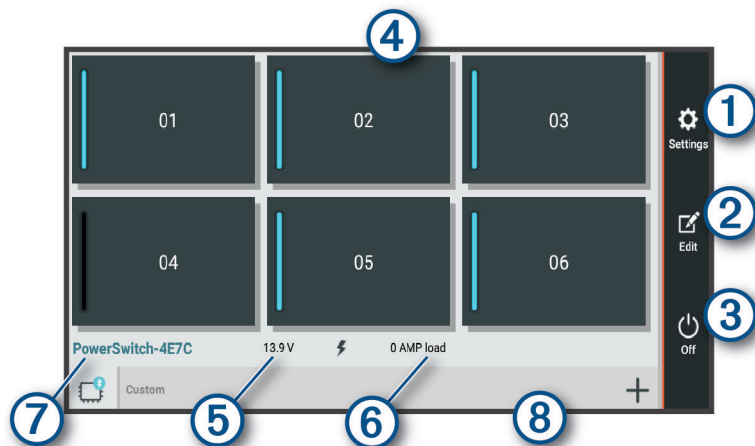
## Garmin PowerSwitch™ App



① 	Opens the app settings menu
② 	Enters editing mode to customize the app layout and functions
③ 	Turns off all outputs
④ Power buttons	Activates each connected output
⑤	Displays input voltage
⑥	Displays the total amperage of the selected Garmin PowerSwitch device
⑦	Displays the device name
⑧	Displays Garmin PowerSwitch device tabs and custom layout tabs

### Activating a Power Switch



Before you can use the Garmin PowerSwitch app to activate a switch, you must install your Garmin PowerSwitch device in your vehicle and pair it with the Garmin PowerSwitch app.

From the Garmin PowerSwitch app, select a power button to turn a switch on or off.

### Turning Off All Switches

Select .

## Customizing a Button

- 1 From the Garmin PowerSwitch app screen, select .  
The app enters editing mode.
- 2 Select  on the button you want to customize.
- 3 Select an option:
  - To change the name of the button, select the **Button Label** field, and enter a name.
  - To add an icon to the button, select the **Icon** field, and select an icon.
  - To change the button color, select a color.
  - To change the button mode, select a button mode.
  - To adjust the intensity of the switch, use the slider.
  - To set the button to activate with a control input, select a control input.
- 4 Select .
- 5 Select **Done**.

## Assigning a Switch to a Control Input



Before you can use control input functions, you must connect a control input to your Garmin PowerSwitch device ([Connecting a Control Input, page 59](#)).

You can assign one or more switches to turn on when the Garmin PowerSwitch device receives a signal from a control input.



- 1 Select .
- 2 Select your Garmin PowerSwitch device.
- 3 Select a control input.
- 4 Select one or more switches.

## Adding a Custom Layout



You can add a custom layout tab to the Garmin PowerSwitch app. Buttons added to a custom layout can control multiple switches at the same time.

- 1 From the Garmin PowerSwitch app, select .  
The device enters editing mode.
- 2 Select .



## Adding a Button to a Custom Layout

- 1 From the Garmin PowerSwitch app, select a custom layout tab.
- 2 Select .  
The app enters editing mode.
- 3 Select **Add Button**.
- 4 On the new button, select .
- 5 Select an option:
  - To change the name of the button, select the **Button Label** field, and enter a name.
  - To add an icon to the button, select the **Icon** field, and select an icon.
  - To change the button color, select a color.
- 6 Select **Add Action**.
- 7 If necessary, select a Garmin PowerSwitch device and a switch.
- 8 Select an action:
  - To set the button to turn the switch on or off with each press, select **Toggle**.
  - To set the button to turn on the switch, select **Turn On**.
  - To set the button to turn off the switch, select **Turn Off**.
- 9 Select a button mode:
  - To set the button to activate with one touch, select **Normal**.
  - To set the button to activate only while touching the button, select **Momentary**.
  - To set the button to turn on and off repeatedly, select **Strobe**, and select time intervals.
- 10 If applicable, use the slider to set the brightness of lights.
- 11 Select .
- 12 If necessary, select **Add Action** to add additional actions for the button.  
You can add one action for every switch on the Garmin PowerSwitch device.

## Arranging Buttons In a Custom Layout

- 1 From the Garmin PowerSwitch app, select a custom layout tab.
- 2 Select .  
The app enters editing mode.
- 3 On the button you want to move, hold , and drag the button to a new location.

## Deleting a Custom Layout or Button

- 1 From the Garmin PowerSwitch app, select a custom layout tab.
- 2 Select .  
The app enters editing mode.
- 3 Select an option:
  - To delete a button, select  on the button you want to delete.
  - To delete a layout tab, select  on the layout tab.

# Overlander Settings

## Navigation Settings

Select  > **Navigation**.

**Vehicle Profile:** Sets the vehicle profile for each vehicle with which you will use your device.

**Map & Vehicle:** Sets the map detail level and the vehicle icon to display on your device.

**Route Preferences:** Sets the route preferences when navigating.

**Driver Assistance:** Sets driver assistance alerts.

**Traffic:** Sets the traffic details the device uses. You can set your device to avoid traffic when calculating routes, and to find a new route to your destination if a traffic delay occurs (*Avoiding Traffic Delays on Your Route*, page 13).

**Units:** Sets the unit of measure used for distances.

## Map and Vehicle Settings

Select  > **Navigation** > **Map & Vehicle**.

**Vehicle:** Sets the vehicle icon that represents your position on the map.

**Driving Map View:** Sets the perspective on the map.

**Map Detail:** Sets the level of detail on the map. More detail may cause the map to draw slower.

**Map Theme:** Changes the color of the map data.

**Map Layers:** Sets the data that appears on the map page (*Customizing the Map Layers*, page 28).

**Auto Zoom:** Automatically selects the zoom level for optimal use of your map. When disabled, you must zoom in or out manually.

**myMaps:** Sets which installed maps the device uses.

## Enabling Maps

You can enable map products installed on your device.

**TIP:** To purchase additional map products, go to <http://buy.garmin.com>.

1 Select  > **Navigation** > **Map & Vehicle** > **myMaps**.

2 Select a map.

## Route Preference Settings

Select  > **Navigation** > **Route Preferences**.

**Route Preview:** Shows a preview of the major roads in your route when you start navigation.

**Calculation Mode:** Sets the route calculation method.

**Avoidances:** Sets road features to avoid on a route.

**Custom Avoidances:** Allows you to avoid specific roads or areas.

**Environmental Zones:** Sets the avoidance preferences for areas with environmental or emissions restrictions that may apply to your vehicle.

**Toll Roads:** Sets preferences for avoiding toll roads.

**NOTE:** This feature is not available in all areas.

**Tolls and Fees:** Sets preferences for avoiding toll roads and toll stickers.

**NOTE:** This feature is not available in all areas.

**Restricted Mode:** Disables all functions that require significant operator attention.

**Voice Language:** Sets the language for navigation voice prompts.

**Travel History:** Allows the device to record information for the myTrends, Where I've Been, and Trip Log features.

**Clear Travel History:** Clears your travel history for the myTrends, Where I've Been, and Trip Log features.

## Driver Assistance Settings

Select  > **Navigation** > **Driver Assistance**.

**Audible Driver Alerts:** Enables an audible alert for each type of driver alert ([Driver Awareness Features and Alerts, page 8](#)).

**Proximity Alerts:** Alerts you when you approach speed cameras or red light cameras.

## Traffic Settings

From the main menu, select  > **Navigation** > **Traffic**.

**Traffic:** Enables traffic.

**Current Provider:** Sets the traffic provider to use for traffic data. The Auto option selects the best available traffic data automatically.

**Subscriptions:** Lists the current traffic subscriptions.

**Optimize Route:** Enables the device to use optimized alternate routes automatically or upon request ([Avoiding Traffic Delays on Your Route, page 13](#)).

**Traffic Alerts:** Sets the traffic delay severity for which the device displays a traffic alert.

## Enabling Bluetooth Wireless Technology

Select  > **Bluetooth**.

## Connecting to a Wireless Network

- 1 Select  > **Wi-Fi**.
- 2 If necessary, select the toggle switch to turn on wireless network technology.
- 3 Select a wireless network.
- 4 If necessary, enter the encryption key.

The device connects to the wireless network. The device remembers the network information and connects automatically when you return to this location in the future.

## Display Settings

Select  > **Display**.

**Brightness Level:** Sets the display brightness level on your device.

**Adaptive Brightness:** Automatically adjusts the backlight brightness based on the ambient light when the device is out of the mount.

**Theme:** Allows you to select day or night color mode. If you select the Automatic option, the device automatically switches to day or night colors based on the time of day.

**Wallpaper:** Sets the wallpaper background on your device.

**Sleep:** Allows you to set the amount of idle time before your device enters sleep mode while using battery power.

**Daydream:** Enables or disables the daydream screen saver.

**Font size:** Increases or decreases the font size on your device.

**When device is rotated:** Enables the screen to rotate automatically between portrait and landscape display modes based on the device orientation or remain in the current orientation.

**NOTE:** While the device is connected to the vehicle mount, it only supports landscape mode.

**Cast:** Enables you to show the contents of the device screen on a compatible external display wirelessly.

## Sound and Notification Settings

Select  > **Sound & notification**.

**Volume Sliders:** Set the volume levels for navigation, media, calls, alarms, and notification alerts.

**Do not disturb:** Sets the rules for the automatic do-not-disturb feature. This feature allows you to disable audible alerts during specific times or events.

**Default notification ringtone:** Sets the default notification ringtone sound on your device.

## Adjusting Sound and Notification Volume

1 Select  > **Sound & notification**.

2 Use the slider bars to adjust the sound and notification volume.

## Enabling or Disabling Location Services

The location services feature must be enabled for your device to find your location, calculate routes, and provide navigational assistance. You can disable location services to save battery power or to plan a route when the device is indoors, away from GPS signals. When location services are disabled, the device enables a GPS simulator to calculate and simulate routes.

1 Select  > **Location**.

2 Select the toggle switch to enable or disable location services.

**NOTE:** For most uses, you should not change the Mode setting from the default option of Device only. The device includes a high-performance GPS antenna that provides the most accurate location data while navigating.

## Setting the Text Language

You can select the language for text in the device software.

1 Select  > **Language & input** > **Language**.

2 Select a language.

## Date and Time Settings

Select  > **Date & Time**.

**Automatic date & time:** Automatically sets the time based on information from the connected network.

**Set date:** Sets the month, day, and year on your device.

**Set time:** Sets the time on your device.

**Select time zone:** Sets the time zone on your device.

**Use 24-hour format:** Enables or disables the 24-hour time format.

## Device Settings

Select  > **About device**.

**System updates:** Allows you to update map and device software.

**Status:** Displays the battery status and network information.



**Legal Information:** Allows you to view the end-user license agreement (EULA) and software license information.

**Regulatory information:** Displays e-label regulatory and compliance information.

**Garmin device information:** Displays hardware and software version information.



## Restoring Settings

You can restore a category of settings to the factory default values.

- 1 Select .
- 2 Select a settings category.
- 3 Select  > **Restore**.

## Resetting Data and Settings

The device offers several options for deleting your user data and resetting all settings to the factory default values.

- 1 Select .
- 2 Select an option:
  - To clear your travel history, select **Navigation > Route Preferences > Clear Travel History**.  
This option deletes all records of the places you have traveled. It does not delete saved locations, accounts, apps, or installed maps.
  - To reset all navigation settings to the factory default values, select **Navigation >  > Restore**.  
This option does not delete any user data.
  - To remove all saved wireless networks and paired devices, select **Device Reset > Network settings reset**.  
This option does not delete any other user data.
  - To delete all user data and reset all settings to the factory default values, select **Device Reset > Factory data reset**.  
This option deletes your travel history, apps, accounts, settings, saved networks, paired devices, and all other user data. Installed maps are not deleted. User files in the Garmin folder may not be deleted.

## Device Information

### Viewing E-label Regulatory and Compliance Information

- 1 From the settings menu, swipe to the bottom of the menu.
- 2 Select **About device > Regulatory information**.

### Specifications

Operating temperature range	From -20° to 55°C (from -4° to 131°F)
Charging temperature range	From 0° to 45°C (from 32° to 113°F)
Radio frequency/protocol	2.4 GHz @ 15 dBm
Power input	Vehicle power using the included vehicle power cable. AC power using an optional accessory (for home and office use only).
Battery type	Rechargeable lithium-ion
Compass-safe distance	30.5 cm (12 in.)

### Charging the Device

**NOTE:** This Class III product shall be powered by an LPS power supply.

You can charge the battery in the device using any of these methods.

- Install the device in the mount, and connect the mount to vehicle power.
- Connect the device to an optional power adapter accessory, such as a wall power adapter.  
You can purchase an approved Garmin AC-DC adapter suitable for home or office use from a Garmin dealer or [www.garmin.com](http://www.garmin.com). The device may charge slowly when connected to a third-party adapter.



# Device Maintenance

## Garmin Support Center

Go to [support.garmin.com](https://support.garmin.com) for help and information, such as product manuals, frequently asked questions, videos, and customer support.

## Updating Maps and Software Using a Wi-Fi Network

### NOTICE

Map and software updates may require the device to download large files. Regular data limits or charges from your internet service provider apply. Contact your internet service provider for more information about data limits or charges.

You can update the maps and software by connecting your device to a Wi-Fi network that provides access to the internet. This allows you to keep your device up to date without connecting it to a computer.

1 Using the included USB cable, connect the device to external power.

**NOTE:** A USB power adapter is not included. Go to the product page on [garmin.com](https://garmin.com) to purchase a power adapter accessory.

2 Connect the device to a Wi-Fi network ([Connecting to a Wireless Network](#), page 48).

While connected to a Wi-Fi network, the device checks for available updates automatically and displays a notification when an update is available.

3 Select an option:

- When an update notification appears, swipe down from the top of the screen, and select **An update is available..**
- To manually check for updates, select  > **About device** > **System updates**.

The device displays available map and software updates. When an update is available, **Update Available** appears below Map or Software.

4 Select an option:

- To install all available updates, select **Download**.
- To install only map updates, select **Map**.
- To install only software updates, select **Software**.

5 If necessary, read the license agreements, and select **Accept All** to accept the agreements.

**NOTE:** If you do not agree with the license terms, you can select **Reject**. This stops the update process. You cannot install updates until you accept the license agreements.

6 Keep the device connected to external power and within range of the Wi-Fi network until the update process is complete.

**TIP:** If a map update is interrupted or canceled before it completes, your device may be missing map data. To repair missing map data, you must update the maps again.

## Updating Maps and Software with Garmin Express

You can use the Garmin Express application to download and install the latest map and software updates for your device.

1 If you do not have the Garmin Express application installed on your computer, go to [garmin.com/express](http://garmin.com/express) and follow the on-screen instructions to install it (*Installing Garmin Express, page 53*).

2 Open the  Garmin Express application.

3 Connect your device to your computer using a micro-USB cable.

The small end of the cable connects to the micro-USB port  on your Overlander device, and the large end connects to an available USB port on your computer.



4 In the Garmin Express application, click **Add a Device**.

The Garmin Express application searches for your device and displays the device name and serial number.

5 Click **Add Device**, and follow the on-screen instructions to add your device to the Garmin Express application.

When setup is complete, the Garmin Express application displays the updates available for your device.

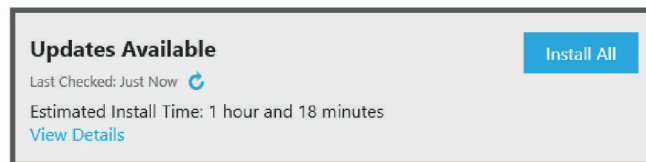

6 Select an option:

- To install all available updates, click **Install All**.
- To install a specific update, click **View Details**, and click **Install** next to the update you want.

The Garmin Express application downloads and installs the updates onto your device. Map updates are very large, and this process may take a long time on slower internet connections.

**NOTE:** If a map update is too large for the internal storage of the device, the software may prompt you to install a microSD card in your device to add storage space (*Installing a Memory Card for Maps and Data, page 63*).

7 Follow the on-screen instructions during the update process to finish installing updates.

For example, during the update process, the Garmin Express application may instruct you to disconnect and reconnect your device.

## Installing Garmin Express

The Garmin Express application is available for Windows® and Mac® computers.

- 1 On your computer, go to [garmin.com/express](http://garmin.com/express).
- 2 Select an option:
  - To view the system requirements and verify the Garmin Express application is compatible with your computer, select **System Requirements**.
  - To install on a Windows computer, select **Download for Windows**.
  - To install on a Mac computer, select **Download for Mac**.
- 3 Open the downloaded file, and follow the on-screen instructions to complete the installation.

## Device Care

### NOTICE

Avoid dropping your device.

Do not store the device where prolonged exposure to extreme temperatures can occur, because it can cause permanent damage.

Never use a hard or sharp object to operate the touchscreen, or damage may result.

Do not expose the device to water.

## Cleaning the Outer Casing

### NOTICE

Avoid chemical cleaners and solvents that can damage plastic components.

- 1 Clean the outer casing of the device (not the touchscreen) using a cloth dampened with a mild detergent solution.
- 2 Wipe the device dry.

## Cleaning the Touchscreen

- 1 Use a soft, clean, lint-free cloth.
- 2 If necessary, lightly dampen the cloth with water.
- 3 If using a dampened cloth, turn off the device and disconnect the device from power.
- 4 Gently wipe the screen with the cloth.

## Avoiding Theft

- Remove the device and mount from sight when not in use.
- Remove the residue left on the windshield by the suction cup.
- Do not keep your unit in the glove compartment.
- Register your device using the Garmin Express software ([garmin.com/express](http://garmin.com/express)).

## Changing the Fuse in the Vehicle Power Cable

### NOTICE

When replacing the fuse, do not lose any of the small pieces and make sure they are put back in the proper position. The vehicle power cable does not work unless it is assembled correctly.

If your device does not charge in your vehicle, you may need to replace the fuse located at the tip of the vehicle adapter.

- 1 Rotate the end piece ① counter clockwise to unlock it.



**TIP:** You may need to use a coin to remove the end piece.

- 2 Remove the end piece, the silver tip ②, and the fuse ③.
- 3 Insert a new fast-blow fuse that has the same current, such as 1 A or 2 A.
- 4 Place the silver tip in the end piece.
- 5 Push in the end piece and rotate it clockwise to lock it back into the vehicle power cable ④.

## Resetting the Device

You can reset your device if it stops functioning.

Hold the power key for 12 seconds.

## Removing the Device, Mount, and Suction Cup

### Removing the Mount from the Suction Cup

- 1 Turn the device mount to the right or left.
- 2 Apply pressure until the socket on the mount releases the ball on the suction cup.

### Removing the Suction Cup from the Windshield

- 1 Flip the lever on the suction cup toward you.
- 2 Pull the tab on the suction cup toward you.

## Troubleshooting

### The suction cup will not stay on my windshield

- 1 Clean the suction cup and windshield with rubbing alcohol.
- 2 Dry with a clean, dry cloth.
- 3 Mount the suction cup (*Mounting and Powering the Device in Your Vehicle*, page 3).

## The mount does not hold my device in place while I drive

For the best results, you should keep the vehicle mount clean and position the device close to the suction cup. If the device shifts position while you are driving, you should complete these actions.

- Remove the powered mount from the suction cup arm, and wipe the ball and socket with a cloth. Dust and other debris may reduce the friction in the ball and socket joint and allow the joint to shift while you are driving.
- Rotate the hinged arm toward the suction cup as far as your windshield angle allows. Positioning the device closer to the windshield reduces the effect of jarring and vibration from the road.

## My device is not acquiring satellite signals

- Verify the location services feature is enabled.
- Take your device out of parking garages and away from tall buildings and trees.
- Remain stationary for several minutes.

## The device does not charge in my vehicle

- Check the fuse in the vehicle power cable (*Changing the Fuse in the Vehicle Power Cable, page 54*).
- Verify the vehicle is turned on and is supplying power to the power outlet.
- Verify the interior temperature of the vehicle is within the charging temperature range indicated in the specifications.
- Verify the fuse is not broken in the vehicle power outlet.

## My battery does not stay charged for very long

- Decrease the screen brightness (*Display Settings, page 48*).
- Shorten the display timeout (*Display Settings, page 48*).
- Decrease the volume (*Adjusting Sound and Notification Volume, page 49*).
- Turn off the wi-fi radio when it is not in use (*Connecting to a Wireless Network, page 48*).
- Put the device in power saving mode when not in use (*Turning the Device On or Off, page 4*).
- Keep your device away from extreme temperatures.
- Do not leave your device in direct sunlight.

## My device does not connect to my phone

- Select  > **Bluetooth**.  
The Bluetooth option must be enabled.
- Enable Bluetooth wireless technology on your phone and bring your phone within 10 m (33 ft.) of the device.
- Verify your phone is compatible.  
Go to [www.garmin.com/bluetooth](http://www.garmin.com/bluetooth) for more information.
- Complete the pairing process again.  
To repeat the pairing process, you must unpair your phone and device (*Deleting a Paired Phone, page 37*), and complete the pairing process.

# Appendix

## Garmin PowerSwitch

### ⚠ WARNING

Garmin strongly recommends having an experienced installer with the proper knowledge of electrical systems install the device. Incorrectly wiring the power cable can result in damage to the vehicle or the battery and can cause bodily injury.

You can use a connected Garmin PowerSwitch device to control lights, fans, and more from your Overlander device.

### Mounting Considerations

- The device must be mounted close to the battery and within the range of the supplied power cable.
- The mounting surface must be strong enough to support the weight of the device.
- The location must allow room for the routing and connection of all cables.

### Mounting the Device

Before you can mount the device, you must select a mounting location and purchase the appropriate hardware for your mounting surface.

### NOTICE

Avoid wires, gauges, air bags, air bag covers, HVAC, and other items when drilling pilot holes and attaching the mount to the vehicle. Garmin is not responsible for any damages or consequences arising from the installation.

- 1 Place the mount on the selected location.



- 2 Using the mount as a template, mark the two screw locations ①.
- 3 Drill pilot holes (optional).  
For some types of mounting material, drilling pilot holes is necessary. Do not drill through the mount.
- 4 Securely fasten the mount to the surface using the appropriate hardware for your mounting surface.

## Opening the Front Cover

You must open the front cover to make electrical connections.

- 1 Lift the front cover latch ① and rotate it counter-clockwise.



- 2 Pull the front cover off of the device.



## Connecting Accessories

### NOTICE

Do not use the device to control or power a winch. Failure to follow this notice could cause damage to your vehicle or your device.

Accessory requirements:

- Verify the amperage rating of each accessory before wiring it to the Garmin PowerSwitch device. The device supports accessories up to 30 A for each channel and a maximum of 100 A for the entire system.
- Use 10 AWG (6 mm<sup>2</sup>) wires for accessories that use 20 to 30 A.
- Use 12 AWG (4 mm<sup>2</sup>) wires for accessories that use 10 to 20 A.
- Use 14 AWG (2.5 mm<sup>2</sup>) wires for accessories that use less than 10 A.
- Use the appropriate size terminals for all accessory connections.
- Crimp all terminal connectors securely.

- 1 Connect the positive wire from the accessory ① to one of the accessory terminals ② on the Garmin PowerSwitch device.

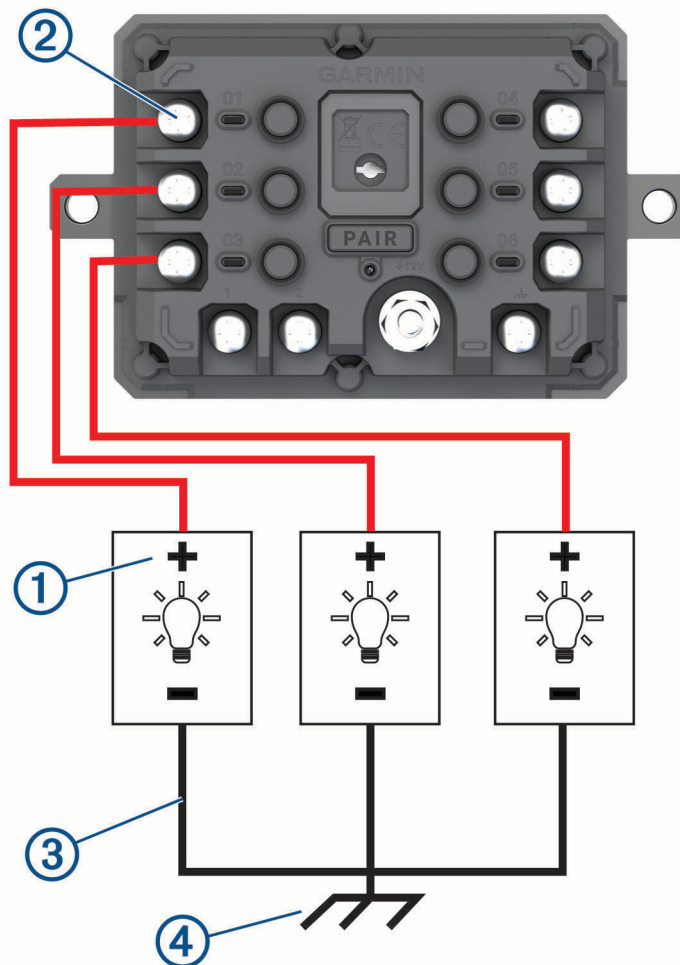

- 2 Connect the negative or ground wire ③ to an unpainted ground stud ④ on the vehicle frame, to a ground distribution block, or directly to the negative terminal on the battery.

### NOTICE

Do not connect the accessory ground wires to the ground terminal (GND) on the Garmin PowerSwitch device. Failure to heed this notice could result in personal or property damage, or negatively impact device functionality.



3 Verify that all electrical connections are tight and will not come loose during use.

### **Connecting a Control Input**

You can connect to the control terminals to enable the Garmin PowerSwitch device to turn on customizable outputs. For example, you can connect your vehicle ignition switch to a control input terminal to turn on accessories automatically each time you start your vehicle. The control terminals detect a signal from 3.3 V to 18 V. You can configure output functions with the Garmin PowerSwitch app.

Connect the control wire from the control source in your vehicle to one of the two control terminals on the Garmin PowerSwitch device.

## Connecting the Device to Vehicle Power

Before you can connect the device to vehicle power, you must remove the warning tag from the +12V terminal on the device.

You should always confirm all electrical connections are secure and will not come loose while operating the device.

- 1 Connect the large ring end of the included ground wire ① to the negative terminal on the vehicle battery.

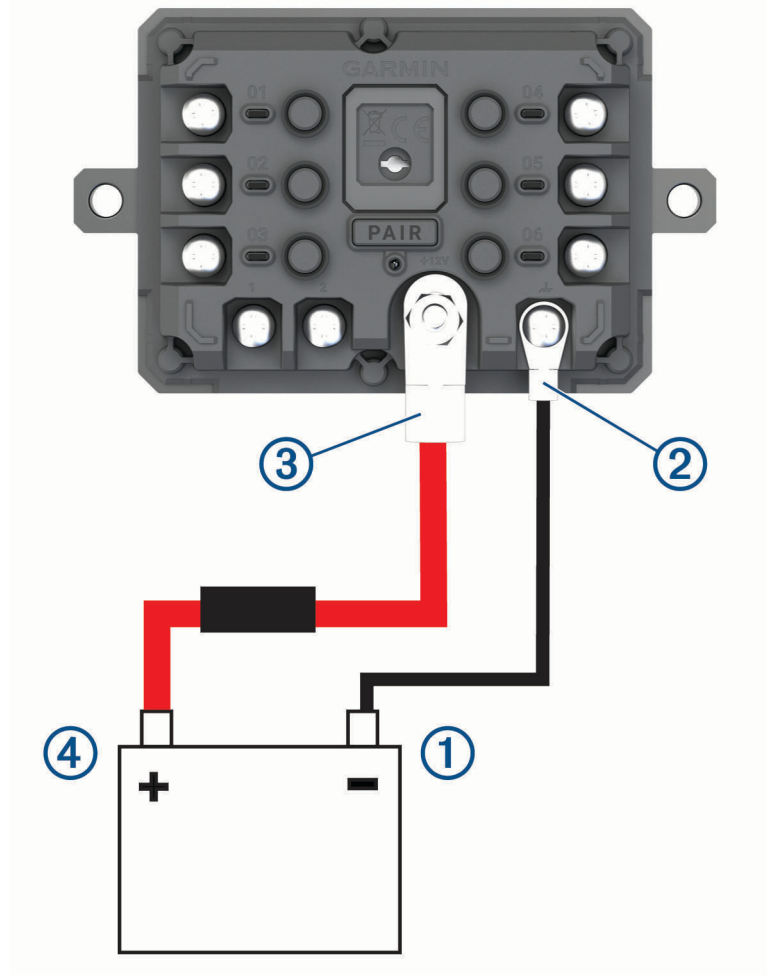

- 2 Connect the small ring end of the ground wire to the **GND** terminal ② on the device.
- 3 Connect the small ring end of the included 12V cable to the **+12V** terminal ③ on the device.
- 4 Tighten the  $\frac{3}{8}$  in. nut on the +12V terminal to a maximum torque specification of 4.52 N-m (40 lbf-in.). You should confirm the nut cannot be loosened by hand.

### NOTICE

Do not overtighten the +12V terminal to prevent damage to the terminal.

- 5 Connect the large ring end of the 12V cable ④ to the positive terminal on the vehicle battery.

## Pairing with a Garmin Navigation Device

You can pair your Garmin PowerSwitch device with a compatible Garmin navigation device.

- 1 Turn on power to your Garmin PowerSwitch device, and place your compatible Garmin navigation device within 1 m (3.3 ft.) of it.
- 2 On your compatible navigation device, open the Garmin PowerSwitch app.
- 3 Follow the on-screen instructions to complete the pairing and setup process.

The main app dashboard appears. After the devices are paired, they connect automatically when they are turned on and within range.

## Garmin PowerSwitch Specifications

Dimensions (D x W x H)	75 x 125 x 32 mm (2.95 x 4.92 x 1.26 in.)
Operating temperature range	From -25° to 85°C (from -13° to 185°F)
Wireless frequency	2.4 GHz @ 15 dBm
Power input	From 12 to 16 V using the included vehicle power cable.
Maximum accessory output	30 A
Maximum system output	100 A
Current draw with all outputs off	3 mA
Water rating	IEC 60529 IPX7 <sup>1</sup>

## Troubleshooting

### My Garmin PowerSwitch will not stay connected

- Verify the Garmin PowerSwitch device is receiving power.
- Verify that Bluetooth technology is enabled on your paired navigation device or smartphone.
- Move the navigation device or smartphone closer to your Garmin PowerSwitch device.
- Verify that your vehicle's battery is supplying at least 12 V of power.

The Garmin PowerSwitch device turns off all outputs automatically to preserve your vehicle's battery if it is receiving less than 11 V of power (*My accessories are not receiving power, page 61*).

### My accessories are not receiving power

- Verify the Garmin PowerSwitch device is receiving power from the vehicle battery.
- Verify that your vehicle's battery is supplying at least 12 V of power.

The Garmin PowerSwitch device turns off all outputs automatically to preserve your vehicle's battery if it is receiving less than 11 V of power. Outputs turn back on when the device detects more than 12 V of power.

- Verify that all electrical connections are secure and will not come loose while operating the vehicle.
- Verify that each connected accessory draws less than 30 A.

If an accessory draws more than 30 A, the device turns off that output automatically.

- Verify that the total system load is less than 100 A.

If the device detects a system load of more than 100 A, it turns off all outputs automatically.

- Inspect all electrical connections for an electrical short circuit.

## Backup Cameras

Your device can display the video feed from one or more connected backup cameras.

<sup>1</sup> The device withstands incidental exposure to water of up to 1 m for up to 30 min. For more information, go to [www.garmin.com/waterrating](http://www.garmin.com/waterrating).

## Pairing a BC™ 35 Backup Camera with a Garmin Navigation Device

You must enable the Wi-Fi setting on your Garmin navigation device before you can connect to a camera.

The BC 35 wireless backup camera is compatible with some Garmin navigation devices with Android™. Go to [garmin.com/bc35](http://garmin.com/bc35) for more information about device compatibility.

You can pair up to four BC 35 wireless backup cameras with your compatible Garmin navigation device.

1 Update your navigation device to the latest software.

Your device may not support the BC 35 camera without the latest software. For more information about updating, see the owner's manual for your navigation device.

2 Turn on the Garmin navigation device, and bring it within 3 m (10 ft.) of the camera.

3 Select  >  > **Rear View**.

4 Select an option:

- If this is the first camera you are connecting to the navigation device, select **Add New Camera**.
- If this is an additional camera you are connecting to the navigation device, select  > **Choose Camera** > **Add New Camera**.

5 Follow the on-screen instructions.

**NOTE:** The pairing code or password is located on the transmitter or the camera.

After you complete the pairing process with a camera for the first time, it connects automatically to the Garmin navigation device.



## Viewing the Backup Camera

### **WARNING**

This device is intended to enhance the situational awareness when used properly. If used improperly, you could become distracted by the display, which could lead to an accident causing serious personal injury or death. Only access the information displayed on the device with a glance. Always maintain awareness of your surroundings and do not stare at the display or become distracted by the display. Focusing on the display could prevent you from avoiding obstacles or hazards.

Your device shows video from the connected backup camera in different ways, depending on how the camera is connected to power.

1 Select an option to show video:

- If the camera is connected to a reverse lamp (recommended), place the vehicle into reverse. The device automatically shows video from the backup camera.
- If the camera is connected to a steady power source, select  >  > **Rear View** to manually view the camera.

2 Select an option to resume normal device operation:

- If the camera is connected to a reverse lamp (recommended), take the vehicle out of reverse. The device automatically resumes normal operation.
- If the transmitter is connected to a steady power source, select  to manually hide the camera.

## Switching Cameras

When multiple backup cameras are transmitting to your device, you can switch between the views from the cameras.

1 Select  >  > **Rear View**.

2 Select  > **Choose Camera**.

3 Select a camera.

The video feed from the camera appears, and the camera name appears at the top of the screen.

## Changing the Camera Orientation

Depending on where the camera is placed on your vehicle, the video on your device may appear upside down or mirrored by default. You can rotate the video horizontally or flip the video vertically to correct the video.

1 Select  >  > **Rear View** >  > **Settings**.

2 Select an option:

- Select **Rotate Video**.

**NOTE:** This is useful for cameras placed on the front or rear of your vehicle.

- Select **Flip Video**.

**NOTE:** This is useful for cameras placed on either side of your vehicle.

## Connecting to a Wireless Display

You can show the contents of the device screen on a compatible external display wirelessly.

1 Bring your device near the wireless display.

2 Select  > **Display** > **Cast**.

3 Select a wireless display.

4 If necessary, enter the PIN.

## Data Management

You can store files on your device. The device has a memory card slot for additional data storage.

**NOTE:** The device is compatible with Windows 7 and newer, and Mac OS 10.4 and newer. Mac computers may require additional third-party software to read and write files on Android devices.

### About Memory Cards

You can purchase memory cards from an electronics supplier, or purchase pre-loaded Garmin mapping software ([www.garmin.com](http://www.garmin.com)). Memory cards can be used to store files such as maps and custom POIs.

### Installing a Memory Card for Maps and Data

You can install a memory card to increase the storage space for maps and other data on your device. You can purchase memory cards from an electronics supplier, or go to [www.garmin.com/maps](http://www.garmin.com/maps) to purchase a memory card with pre-loaded Garmin mapping software. The device supports microSD memory cards from 4 to 256 GB. Memory cards must use the FAT32 file system format. Memory cards greater than 32 GB must be formatted using the device (*Formatting the Memory Card, page 63*).

1 Locate the map and data memory card slot on your device (*Device Overview, page 2*).

2 Insert a memory card into the slot.

3 Press it in until it clicks.

### Formatting the Memory Card

The device requires a memory card formatted using the FAT32 file system. You can use the device to format your card using this file system.

You must format a brand new memory card if it is not formatted using the FAT32 file system.

**NOTE:** Formatting the memory card deletes all data on the card.

1 Select  > **Storage & USB**.

2 Select your memory card.

3 Select  > **Settings** > **Format** > **ERASE & FORMAT**.

4 Select **Done**.

## Connecting the Device to Your Computer

You can connect the device to your computer using a USB cable.

- 1 Plug the small end of the USB cable into the port on the device.
- 2 Plug the larger end of the USB cable into a port on your computer.

Depending on your computer operating system, the device appears as either a portable device, a removable drive, or a removable volume.

## Transferring Data From Your Computer

- 1 Connect the device to your computer (*Connecting the Device to Your Computer, page 64*).

Depending on your computer operating system, the device appears as either a portable device, a removable drive, or a removable volume.

- 2 On your computer, open the file browser.
- 3 Select a file.
- 4 Select **Edit > Copy**.
- 5 Browse to a folder on the device.

**NOTE:** For a removable drive or volume, you should not place files in the Garmin folder.

- 6 Select **Edit > Paste**.

## Purchasing Additional Maps

- 1 Go to your device product page at [garmin.com](http://garmin.com).
- 2 Click the **Maps** tab.
- 3 Follow the on-screen instructions.

## Purchasing Accessories

Go to [garmin.com/accessories](http://garmin.com/accessories).

# Index

## Symbols

2-D map view **28**  
3-D map view **28**

## A

accessories **56, 64**  
active lane guidance **11**  
addresses, finding **18**  
alarm volume **49**  
alerts **8, 33**  
    audio **48**  
    proximity points **48**  
altimeter **33**  
AM **42**  
amplifier **43**  
answering calls **36**  
app overview **44**  
applications **29**  
apps **5**  
audio, proximity points **48**  
auxiliary input **41**  
avoidances **14**  
    area **14**  
    deleting **14**  
    disabling **14**  
    road **14**  
    road features **14**  
    tolls **13**

## B

backup camera **62, 63**. See cameras  
barometer **33**  
bass **41**  
battery  
    charging **3, 50, 55**  
    maximizing **55**  
    problems **55**  
Bluetooth devices **39**  
Bluetooth technology **35, 55**  
    deleting a paired device **37**  
    disconnecting a device **37**  
    enabling **48**  
brightness **6**

## C

calibrating, compass **34**  
calls **35, 36**  
    answering **36**  
camera, pairing **62**  
cameras **62, 63**  
    backup **62**  
    red light **8**  
    speed **8**  
    switching **62**  
camper, profiles **7**  
changing the search area **20**  
charging the device **3, 50, 55**  
cleaning the device **53**  
cleaning the touchscreen **53**  
compass **33, 34**  
computer, connecting **63, 64**  
control input **45**  
coordinates **22**  
current location **22**  
custom POIs **21**

## D

data  
    storing **29**  
    transferring **29**  
deleting  
    all user data **50**  
    paired Bluetooth device **37**

destinations **39**. See locations  
    arriving **11**  
detours **12**  
device care **53**  
directions **11**  
disconnecting, Bluetooth device **37**  
display settings **48**  
driver alerts **8**  
driving directions **11**  
DSP **42**

## E

emergency services **22**  
EULAs **49**  
extras, custom points of interest **21**

## F

files, transferring **32, 64**  
finding locations. **15–17, 19, 20** See also  
    locations  
    addresses **18**  
    categories **15**  
    cities **21**  
    coordinates **22**  
    intersections **21**  
finding services **16**  
FM **42**  
Foursquare **17**  
fuel, stations **22**  
fuse, changing **54**

## G

gain **41**  
Garmin Explore **15, 30–32**  
Garmin Express **53**  
    updating software **52**  
going home **9**  
GPS **5**  
    simulator **49**

## H

headset, pairing **36**  
history, sending to computer **29**  
home  
    editing location **9**  
    going **9**  
home screen **5**  
    customizing **6**

## I

icons, status bar **6**  
ID number **49**  
inReach **34**  
inReach remote **34**  
intersections, finding **21**

## L

language **49**  
latitude and longitude **22**  
location services **49**  
locations **18, 31, 39**  
    current **22, 23**  
    recently found **22**  
    saving **23**  
    searching for **15, 21**  
    simulated **49**  
    venues **18**

## M

map layers, customizing **28**  
map view  
    2-D **28**  
    3-D **28**  
maps **9, 24, 27, 30, 47**  
    adding **30**  
    data field **10, 27, 28**  
    detail level **47**  
    layers **28**

    purchasing **64**  
    symbols **10**  
    theme **47**  
    tools **24**  
    updating **30, 51, 52**  
    viewing routes **10, 11**  
media player **40**  
    source **40**  
media volume **49**  
memory card **2, 63**  
    formatting **63**  
    installing **63**  
message **34**  
microSD card **2, 63**  
mount, removing **54**  
mounting the device **55–60**  
    automobile **3**  
    suction cup **3, 54**  
music player **40**  
mute **41**  
muting, audio **39**  
myTrends, routes **13**

## N

national parks **16**  
navigation **10, 11, 18**  
    off-road **31**  
    settings **47**  
next turn **10**  
notification volume **49**  
notifications **6**

## O

owner's manual **39**

## P

pairing **36, 61**  
    deleting a paired device **37**  
    disconnecting **37**  
    headset **36**  
    phone **35, 55**  
parking **11, 19–21**  
phone  
    disconnecting **37**  
    pairing **35, 36, 55**  
phone calls **35, 36**  
    answering **36**  
    dialing **36**  
    muting **36**  
    voice dial **36**  
pitch and roll **33**  
    calibrating **33**  
POI Loader **21**  
points of interest (POI) **15–18**  
    custom **21**  
    extras **21**  
    HISTORY **17**  
    POI Loader **21**  
    venues **18**  
power cables **50**  
    changing the fuse **54**  
    vehicle **3, 58–60**  
power key **2, 4**  
power switch **44**  
    customizing **45, 46**  
presets **42**  
product support **39**  
profiles, camper **7**

## Q

Quick Search **15**

## R

recently found locations **22**  
red light cameras **8**  
removing mount **54**

- resetting **43**
  - device **54**
  - trip data **27**
- resetting the device **50**
- restoring settings **50**
- restrictions, vehicle **7**
- routes **9, 31**
  - adding a point **12**
  - calculating **12**
  - myTrends **13**
  - shaping **12**
  - starting **9, 19, 20**
  - stopping **13**
  - suggested **13**
  - viewing on the map **10, 11**

## S

- satellite signals, acquiring **5, 49**
- saved locations
  - categories **23**
  - deleting **24**
  - editing **23**
- saving, current location **23**
- screen, brightness **6**
- search bar **18**
- settings **30, 32, 42, 43, 47–49**
- shaping a route **12**
- shortcuts
  - adding **6, 22**
  - deleting **23**
- simulated locations **49**
- sleep mode **4**
- smartphone **29**
- software
  - updating **51, 52**
  - version **49**
- SOS **34**
  - canceling **35**
  - sending **35**
- sound **49**
- source **40**
- speaker zones **41, 43**
- specifications **50, 61**
- speech recognition **38**
- speed cameras **8**
- storing data **29**
- subwoofer **42**
- suction cup **54**

## T

- theft, avoiding **53**
- time settings **49**
- tolls, avoiding **13**
- tone **41**
- tools, maps **24**
- touchscreen **6**
- tracking **32, 33**
- tracks **32**
- traffic **27, 37, 38, 48**
  - alternate route **13**
  - incidents **28, 38**
  - map **28, 38**
  - receiver **37**
  - searching for delays **28, 38**
- travel history **49**
- treble **41**
- trip information **27**
  - resetting **27**
  - viewing **27**
- trip log, viewing **27**
- TripAdvisor **17**
- troubleshooting **54, 55, 61**
- turn list **11**

## U

- unit ID **49**

- up ahead **24, 25**
  - customizing **25**
- updating
  - maps **51, 52**
  - software **51, 52**

## V

- vehicle power cable **3, 60**
- vehicle profile
  - camper **7**
  - car **7**
- venues **18**
- voice command **38**
  - activating **38**
  - navigating with **39**
  - tips for using **38**
  - wakeup phrase **38**
- volume **43, 49**
  - adjusting **41**

## W

- warning angle **33**
- warning icons **25–27**
- waypoints **31**
- Where Am I? **22, 23**
- Wi-Fi, connecting **40, 48, 63**
- Wi-Fi **51**
- wireless camera. See cameras
- wireless devices **34**





