

# How to set up your Marmot Torreya 4P/6P Tent

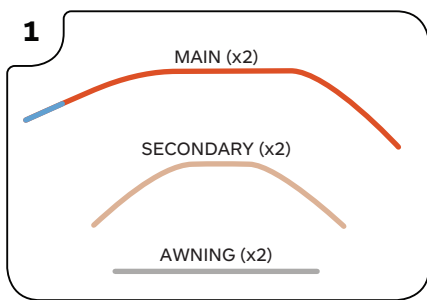

LAY OUT ALL POLES.

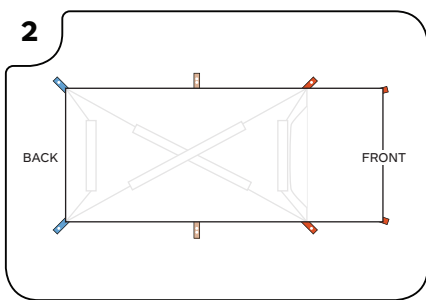

LAY OUT TENT CANOPY FLAT ON GROUND.

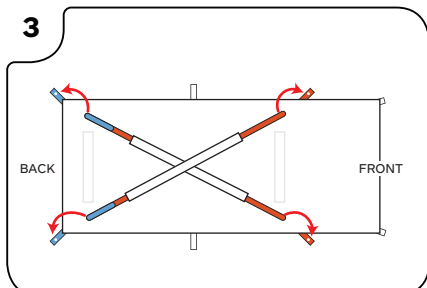

INSERT MAIN POLE TIPS THROUGH POLE SLEEVES AND INTO GROMMETS. POLES SHOULD MATCH CORNER COLORS.

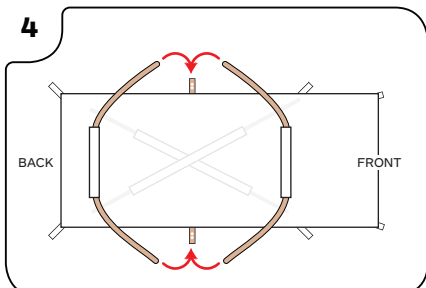

INSERT SECONDARY POLE TIPS THROUGH POLE SLEEVES AND INTO GROMMETS LOCATED ALONG TENT SIDES IN MATCHING COLOR.

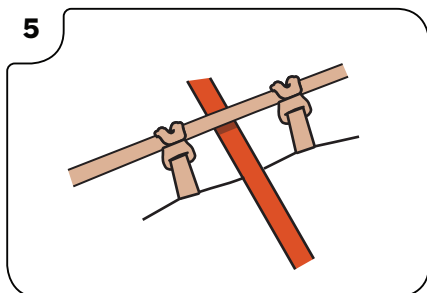

CONNECT CLIPS TO POLES. MATCH CLIP COLOR TO POLE COLOR. SECONDARY POLES SHOULD SIT ON TOP OF PRIMARY.

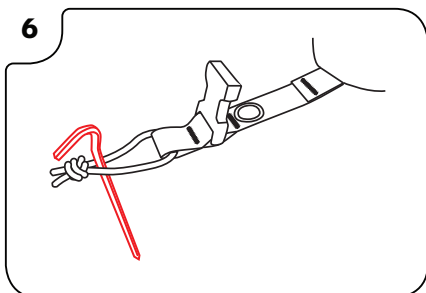

STAKE OUT TENT AT CORNERS AND ALONG TENT EDGES USING THE WEBBING STAKE OUT LOOPS ATTACHED TO THE TENT BODY.

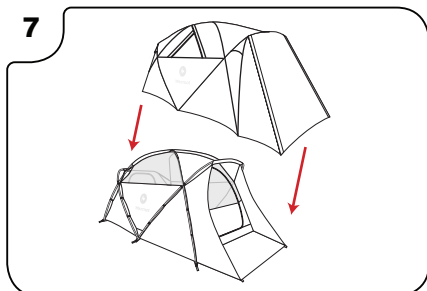

PULL RAINFOLY OVER TENT BODY.

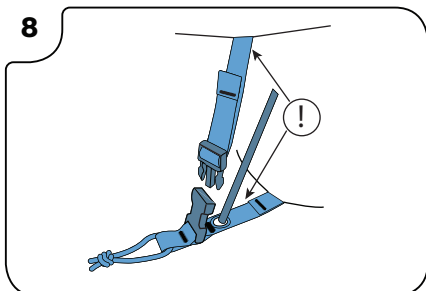

\*\* NOTE: WEBBING ATTACHMENT POINTS ALONG THE PERIMETER OF THE TENT AND FLY SHOULD MATCH IN COLOR. YELLOW TABS INDICATE FRONT OF TENT.

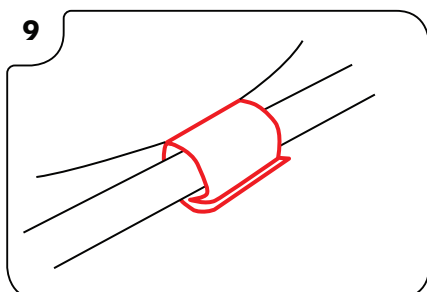

LOOK UNDER FLY - VELCRO FLY TO TENT POLES FOR BEST FIT. FLY SHOULD NOT TOUCH CANOPY

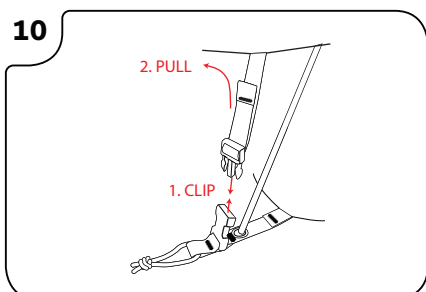

BUCKLE FLY TO CANOPY AT ALL ATTACHMENT POINTS ALONG THE TENT AND PULL WEBBING TO TIGHTEN.

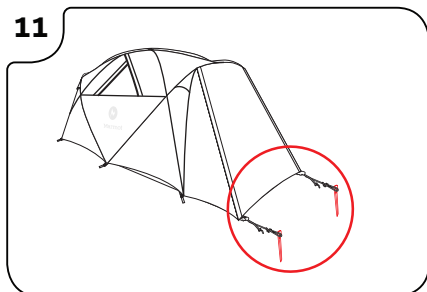

STAKE OUT VESTIBULES.

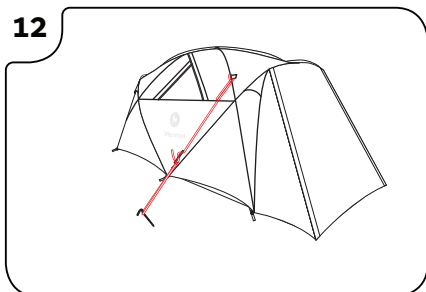

GUY OUT IN HIGH WIND.