

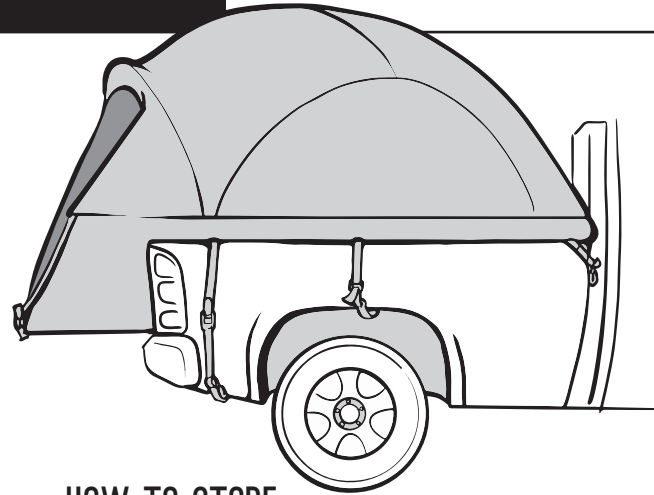

INSTRUCTIONS

BACKROADZ[®] TRUCK TENT 19 SERIES

BEFORE YOU BEGIN



CAMPSITE SELECTION

- Select a smooth, level campsite clear of rocks, branches, and other hard or sharp objects
- Avoid areas with overhead power lines and tree limbs
- Park the vehicle in the chosen campsite
- Turn the engine off and engage the parking brake

HOW TO STORE

1. Clean and dry the tent
2. Fold all of the components into the tent
3. Roll the tent, using the pole bag as a guide
4. Secure with the tent tie straps and insert into the carrying bag
5. Store in a cool, dry place

WARRANTY INFORMATION

Napier tents have a one (1) year warranty period from the time of purchase against defects in improper workmanship. Normal wear and tear, seam leakage through needle holes, and improper use, abuse, or alteration are not covered under the warranty policy. Napier Outdoors will replace or repair defective parts. Replacement parts may be new or re-built at Napier's sole discretion. E-Warranty claim forms can be completed online at www.napieroutdoors.com/warranty. Proof of purchase (receipt) must be provided. If you do not provide proof of purchase, or if your warranty period has ended, replacement parts can be purchased.

To order replacement parts, contact Napier Outdoors at 800-567-2434 (9:00 am – 5:00 pm EST), visit www.napieroutdoors.com, or email customerservice@napieroutdoors.com

CAUTION

- Do not use candles, matches, or open flames of any kind in or near the tent
- Do not cook inside the tent
- Build campfires downwind and several meters away from the tent. Be sure to fully extinguish fires before leaving a campsite or before retiring for the night
- Exercise extreme caution when using fuel-powered lanterns or heaters inside or around the tent. Use battery-operated lanterns whenever possible
- Do not refuel lamps, heaters, or stoves inside the tent
- Extinguish or turn off all lanterns before going to sleep
- Do not smoke inside the tent
- Do not store flammable liquids inside the tent
- NEVER run the vehicle engine when the tent is attached
- Do not install the tent when the temperature is below 0°C/32°F or when your vehicle is wet, it may cause damage
- Allow adequate ventilation inside the tent at all times
- Do not attempt to drive the vehicle with the tent attached

⚠ WARNING

- Keep all flame and heat sources away from the tent fabric. The tent is made with flame-resistant fabric which meets CPAI-84 specifications. This does not make it fireproof. The fabric will burn if left in contact with any flame source. The application of any foreign substance to the tent fabric may render the flame-resistant properties ineffective.
- To prevent carbon monoxide from entering the vehicle and tent area, do not run the engine, do not cook inside the tent, and do not use a gas heater in the tent. Carbon monoxide is dangerous to your health.
- Engine must be off and exhaust must be fully cooled before tent installation and use.

PACKAGE CONTENTS

Remove contents from the bag and ensure you have all components listed below.

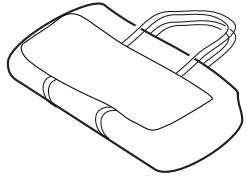

TENT BAG



TENT TIE STRAPS (2)

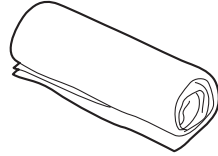

TENT

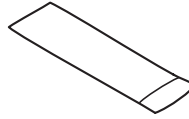

POLE BAG

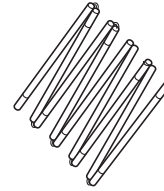

TENT POLES (4)

Black (2)	144.5" - 166.5"	Corner-to-Corner
Green (1)	76" - 89"	Front-to-Back
Grey (1)	145.6" - 150"	Vestibule/Tailgate

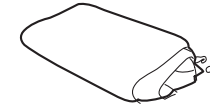

RAINFLY

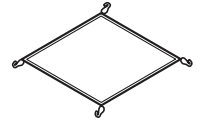

GEAR LOFT

If you are missing parts, please contact Napier Outdoors at 800-567-2434 | Monday - Friday or email customerservice@napieroutdoors.com

TENT SET UP

For an easier assembly, set the tent up on the ground, completing steps 1-3 last.

- 1 Lay the tent flat inside the bed of the truck, ensuring the front door is at the tailgate.



- 2 Locate the tent side straps (3 per side) and loosely attach each to the truck's body.

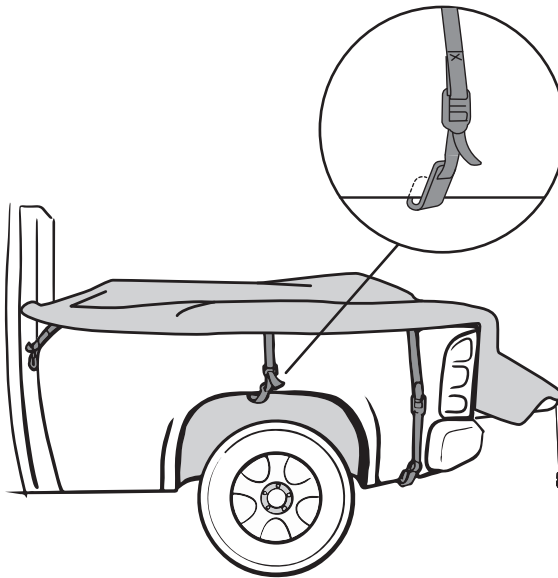

- 3 Locate the tent tailgate straps (3). Slide the back 3 straps between the truck box and the tailgate (you may need to lift the tailgate). Locate the front straps at the end of the tailgate and connect to the corresponding back strap under the tailgate.

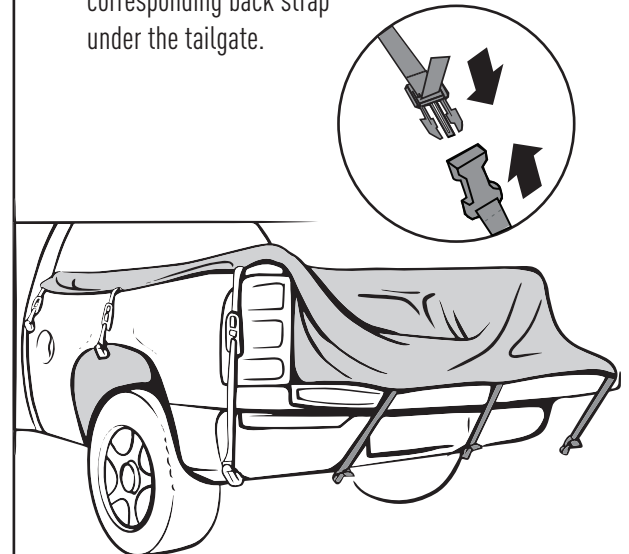

- 4 Assemble the tent poles by unfolding each section.

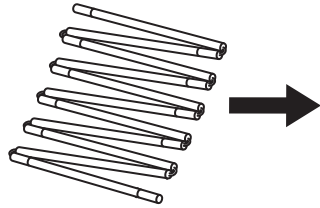

POLE	LOCATION
Black Poles	Corner-to-Corner
Green Pole	Front-to-Back
Grey Pole	Vestibule/Tailgate

- 5 Insert the poles into the corresponding color sleeve in the following order (**do not place the poles in the corner pockets at this time**):

- Insert the BLACK pole diagonally, corner-to-corner on the roof of the tent. Repeat with the other black pole.
- Insert the GREEN pole front-to-back on the roof of the tent.
- Insert the GREY pole side-to-side at the front (tailgate) of the tent.

The poles may get stuck in the sleeve. Do not force them – gently guide the pole through the fabric sleeve.

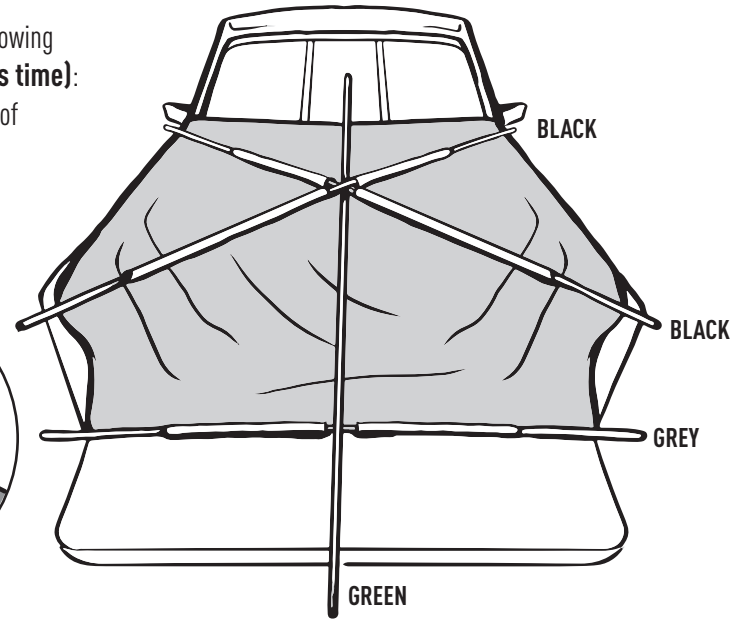
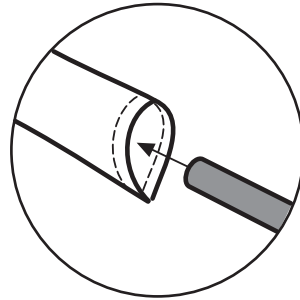

- 6 Insert each pole into the corresponding colored pockets in the following order:

- GREEN (front-to-back) pole
- BLACK (corner-to-corner) poles
- GREY (side-to-side tailgate) pole

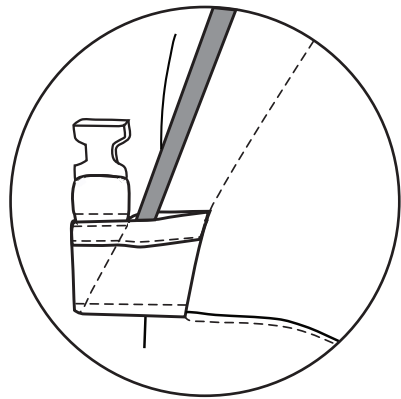

- 7 Once the tent is fully raised, attach the pole clips to the poles.

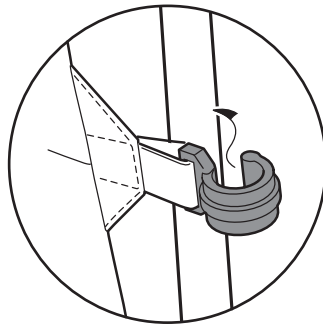

- 8 If the tent straps on the side of the truck are too loose, pull to tighten. Ensuring not to make them too tight.

- 9 To install the gear loft, place each corner hook of the gear loft into the loop located on the ceiling of the tent.

ATTACHING THE RAINFLY

- 10 Locate the front of the rainfly that goes over the door (it will have a black Backroadz tag on the side). Drape the rainfly over the tent.
- 11 Secure the rainfly strap clips to the tent (2 per side and 2 at the tailgate) and tighten if necessary.

